

*Day systems,*  
devised to display  
and storage;  
defining new aesthetics  
of the living area.

7 Bookcases

10 Zenit, 26 Opus, 40 Wind

55 Storage unit systems

58 Alambra, 102 Self, 116 Self bold, 134 Self up,  
160 Abacus living

183 Storage systems

186 Cover, 204 Cover freestanding

Dalle librerie agli espositori vetrina, dai sistemi componibili alle madie: la collezione Day systems raccoglie tutte le proposte Rimadesio dedicate al contenimento per la zona giorno. Soluzioni definite per specifiche funzioni, caratterizzate da un'estrema attenzione ad ogni dettaglio, da un design rigoroso e dalle infinite possibilità di personalizzazione grazie ad un'ampia scelta di materiali e finiture esclusive.

Von Regalen bis Vitrinen, von modularen Systemen bis zu Sideboards: Die Day systems Kollektion umfasst alle Rimadesio Produkte für den Wohnbereich. Sie umfasst Lösungen für spezifische Funktionen, die sich durch extreme Aufmerksamkeit für jedes Detail durch ein rigoroses Design und durch die unendlichen Anpassungsmöglichkeiten dank einer großen Auswahl an Materialien und exklusiven Oberflächen auszeichnen.

Des bibliothèques aux vitrines, des systèmes modulaires aux bahuts: la collection Day systems regroupe tous les produits Rimadesio dédiés au rangement pour la zone jour. Des solutions définies pour des fonctions spécifiques, caractérisées par une extrême attention à chaque détail, par un design rigoureux et par les possibilités infinies de personnalisation, grâce à un large choix de matériaux et de finitions exclusives.

De las librerías a las vitrinas, de los sistemas modulares a los aparadores: la colección Day systems incluye todos los productos Rimadesio dedicados a la contención para la zona día. Soluciones definidas para funciones específicas, caracterizadas por una extrema atención a cada detalle, por un diseño riguroso y por las infinitas posibilidades de personalización gracias a una amplia selección de materiales y acabados exclusivos.

**From bookcases to display cabinets, from modular systems to sideboards: the Day systems collection includes all Rimadesio products dedicated to storage for the living area. Solutions defined for specific functions, characterized by an extreme attention to every detail, by a rigorous design and by the infinite possibilities of customization thanks to a wide choice of materials and exclusive finishes.**

# Bookcases



10 Zenit, 26 Opus, 40 Wind



Design Giuseppe Bavuso

## Zenit

The iconic bookcase of the Rimadesio collection in the pursuit of lightness and project versatility. The uprights, fixed from floor to ceiling and always custom-made, allow a free positioning of the elements, in the desired number and at the desired height. The exclusive hooking system element guarantees the maximum structural solidity and allows to level every element.

La libreria all'insegna della leggerezza e della versatilità compositiva. I montanti, fissati da terra a soffitto e sempre su misura, permettono una libera disposizione delle attrezzature, nel numero e all'altezza desiderata. Un progetto versatile, pensato per esporre e contenere, destinato alla casa e agli spazi professionali. La varietà delle finiture, dal vetro alle essenze fino alle superfici in alluminio, consente una perfetta integrazione stilistica in ogni ambiente.

Das Bücherregal zeichnet sich durch Leichtigkeit und Vielseitigkeit aus. Die in Sondermaßen Pfosten, vom Boden bis zum Decke fixiert, ermöglichen dem Kunden eine freie Anordnung der Ausrüstung, in der gewünschten Anzahl und Höhe. Dies ist ein vielseitiges, für den häuslichen und professionellen Raum bestimmtes Modell, das entworfen wurde, um hergezeigt zu werden und um etwas zu verstauen. Die Vielfalt an Oberflächenmaterialien, von Glas über Holz bis zu den Aluminiumoberflächen, ermöglicht eine perfekte stilistische Integration in jeder Umgebung.

La bibliothèque caractérisée par la légèreté et la polyvalence de la composition. Les montants, fixés du sol au plafond et toujours sur mesure, permettent une disposition libre de l'équipement, dans le nombre et à la hauteur désirées. Un projet polyvalent, conçu pour exposer et contenir, destiné à la maison et aux espaces professionnels. La variété des finitions, du verre au bois, aux surfaces en aluminium, permet une intégration stylistique parfaite dans chaque environnement.

La librería se caracteriza por su ligereza y versatilidad compositiva. Los montantes, fijados al suelo y techo y siempre a medida, permiten una disposición libre del equipamiento, en el número y altura deseados. Un proyecto versátil, diseñado para exhibir y contener, destinado para el hogar y espacios profesionales. La variedad de acabados, del vidrio a las esencias y superficies de aluminio, permite una perfecta integración estilística en cualquier entorno.

Il montante in alluminio e l'esclusivo sistema di aggancio garantiscono la massima solidità strutturale alle composizioni Zenit. Il sistema di aggancio a baionetta consente di posizionare in bolla ogni singolo elemento. I montanti sono disponibili "a soffitto" e "a parete" per consentire la collocazione del sistema in ogni ambiente.

The aluminium upright and the exclusive fixing system guarantee the maximum structural solidity. The bayonet fixing system allows every single element to be installed perfectly leveled. The wall and ceiling uprights allow any possible composition.

Der Aluminium Pfosten sowie das exklusive Befestigungssystem garantieren die maximale strukturelle Zuverlässigkeit der Zenit Kompositionen. Das "Bajonett" Befestigungssystem ermöglicht die perfekt waagrechte Befestigung eines jeden Elementes. Die Pfosten sind sowohl mit Decken- als auch Wandbefestigung erhältlich und ermöglichen die Montage in jeder Situation.

Le profil en aluminium et le système exclusif de fixation garantissent une solidité structurale maximum. Le système particulier de fixation permet de positionner parfaitement chaque élément. Grâce aux profils disponibles, "à plafond" et "à mur", il est possible d'installer Zenit partout.

El montante de aluminio y el exclusivo sistema de fijación garantizan la máxima solidez estructural a las composiciones Zenit. El particular sistema de anclaje permite posicionar de manera perfectamente alineada cada elemento. Los montantes están disponibles "a techo" y "a pared" para permitir la colocación del sistema en cualquier ambiente.

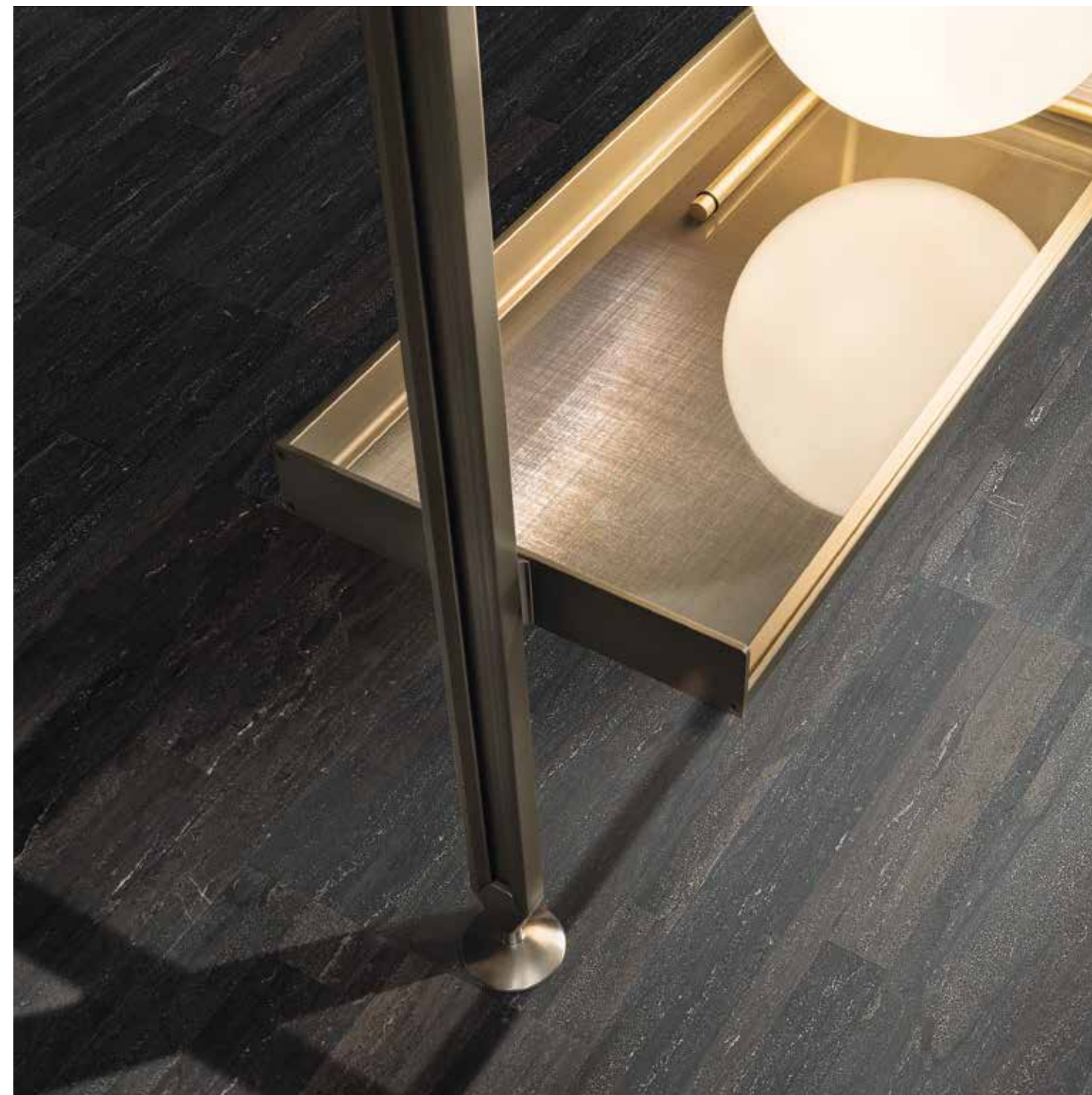





Rimadesio propone soluzioni monocromatiche per interpretare la contemporaneità all'insegna di una neutralità di grande impatto: un "total look" reso possibile dall'esclusiva tecnologia aziendale nella lavorazione del vetro e del metallo. Il vetro: un materiale che Rimadesio riesce a rendere sempre esclusivo. Nelle nuove proposte di abbinamento cromatico, il sistema Zenit affianca i vetri laccati lucidi e opachi, i vetri trasparenti e i vetri acidati.

Rimadesio offers monochromatic solutions to interpret contemporary life in quest of high impact neutrality: a "total look" made possible by the company's exclusive technology in the working of glass and metal. The glass: an always exclusive material with Rimadesio. With the new colour combination proposals, Zenit system combines glossy and mat glasses, transparent and etched glasses.

Rimadesio bietet einfarbige Lösungen an, um die Modernität im Zeichen einer sehr wirksamen Neutralität zu interpretieren: ein "total look", der durch die exklusive Technologie möglich wird, die der Betrieb in der Verarbeitung von Glas und Metall anwendet. Das Glas: ein immer exklusives Material bei Rimadesio. Bei den neuen Kombinationen-Vorschläge, benutzt das System Zenit lackierte Gläser glänzend sowie mat, transparente sowie satinierte Gläser.

Rimadesio propose des solutions monochromatiques pour interpréter la contemporanéité à l'enseigne d'une neutralité de grand impact: un "total look" rendu possible par la technologie exclusive de l'entreprise pour le travail du verre et du métal. Le verre: un matériau qui devient toujours exclusif chez Rimadesio. Dans les nouveautés chromatiques le système Zenit combine verre laqué brillant et mat, verre transparent et verre acidé.

Rimadesio propone soluciones monocromáticas para interpretar la contemporaneidad caracterizada por una neutralidad de gran impacto: un "total look" posible gracias a la exclusiva tecnología de la empresa a la hora de elaborar el cristal y el metal. El cristal: un material que Rimadesio logra hacer siempre exclusivo. En las nuevas propuestas de combinación de colores, el sistema Zenit combina los cristales lacados brillantes y mates, los cristales transparentes y los cristales acidados.









Struttura *Structure*: 24 piombo spazzolato  
 Vetro *Glass*: 63 grigio trasparente  
 Maniglia *Handle*: 24 piombo spazzolato



Struttura *Structure*: 24 piombo spazzolato  
 Mensolone attrezzato in vetro *Glass shelf holder*: 127 piombo opaco

## Modularità Modular structure

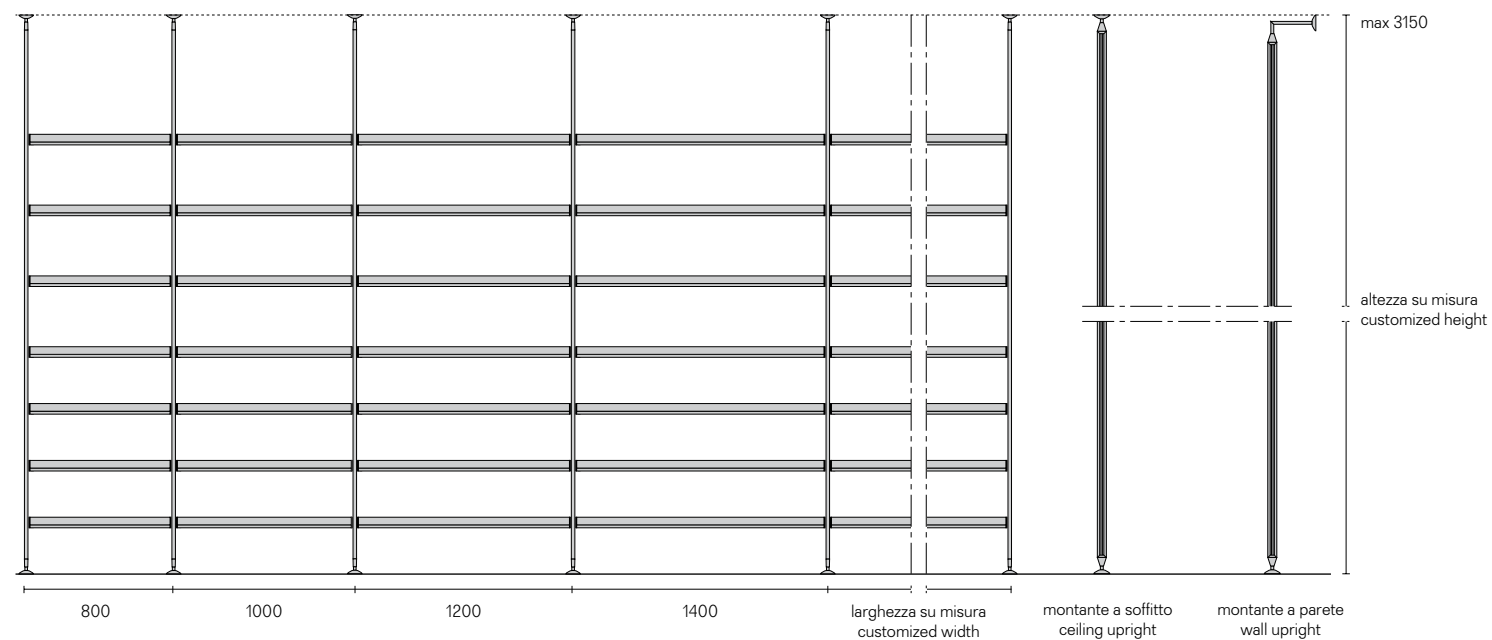

Ingombri composizione con solo mensole  
Encumbrance of the composition with shelves only

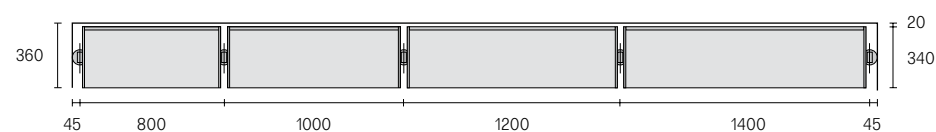

Ingombri composizione lineare con cassetteria e mensolone tv/HiFi  
Encumbrance of the linear composition with drawer unit and tv/HiFi top shelf holder

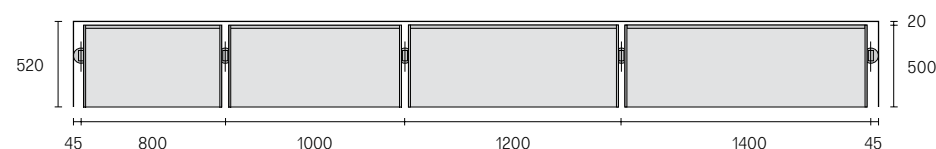

## Descrizione tecnica Technical description

Le composizioni Zenit vengono sempre realizzate su misura in altezza, con possibilità di montanti a parete o a soffitto. Le mensole e i mensoloni sono disponibili in quattro larghezze, fino alla dimensione massima di 140 cm, con inoltre la possibilità di riduzione a misura in larghezza. Tutti gli altri componenti sono disponibili solo nella larghezza indicata.

Zenit compositions are always custom-made in height, with wall or ceiling uprights. Shelves and shelf holders are available in four widths, up to a maximum size of 140 cm, with the possibility to reduce on size in width. All other components are only available in the indicated width.

Zenit Anlage sind immer nach Mass in Höhe, mit Wand oder Decke-Pfosten hergestellt. Fachböden und Top-Fachböden sind mit vier Breiten verfügbar in larghezza, bis zu einer maximalen Breite von 140 cm. Es ist auch möglich sie nach Mass zu kürzen. Die andere Zubehöer sind nur mit der angegebenen Breite verfügbar.

Les compositions Zenit sont toujours sur mesure en hauteur, avec les montants à fixation murale ou au plafond. Les étagères, et les étagères base sont disponibles en quatre largeurs, jusqu' à une dimension maxi de 140 cm, avec la possibilité de les réduire sur mesure in larghezza. Tous les autres accessoires sont disponibles seulement dans la dimension indiquée.

Las composiciones Zenit están siempre realizadas a medida en altura, con posibilidad de montantes a pared o a techo. Los estantes, y los estantes base están disponibles en cuatro anchuras, hasta el tamaño máximo de 140 cm, con la posibilidad de reducción a medida in larghezza. Los otros accesorios están disponibles sólo en la anchura indicada.

## Componenti Components

Mensolone attrezzato per tv-HiFi con ripiano inferiore porta decoder  
TV-HiFi shelf base with bottom shelf for decoder.

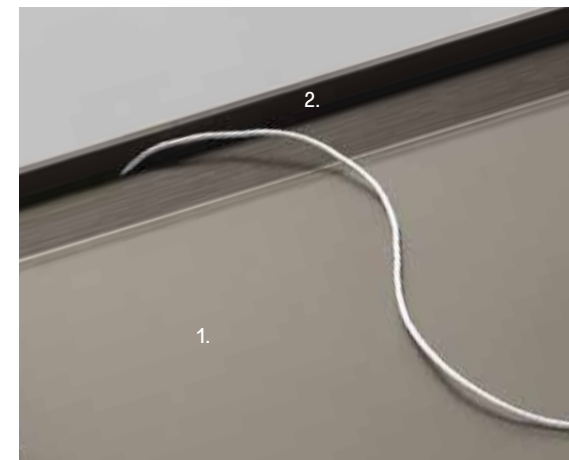
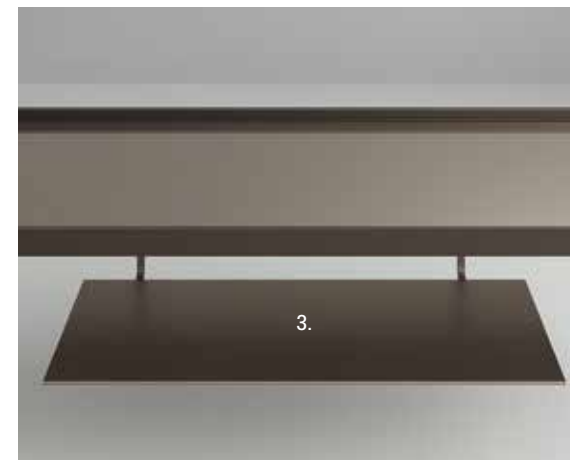

1. Vetro temperato laccato opaco caffè. / Caffè mat tempered lacquered glass.
2. Canalina passacavi in finitura alluminio brown. / Cable duct in brown aluminium finish.
3. Ripiano porta decoder in alluminio laccato. / Bottom shelf for decoder in aluminium.

Cassetteria sospesa  
Suspended drawer unit



1. Maniglia in finitura alluminio brown. / Handle in brown aluminium finish.
2. Struttura interna del cassetto in melaminico cuoio brown. Guide ad estrazione totale con autorientro silenzioso. Drawer's internal leather structure in brown melamine. Totally extractable runners with soft closing device.
3. Vetro temperato laccato opaco caffè. / Caffè mat tempered lacquered glass.

Mensola in vetro temperato con ring in alluminio.  
Tempered glass shelf with aluminium ring.

Mensolone attrezzato per tv-HiFi in vetro laccato con struttura e canalina passacavi in alluminio. Ripiano inferiore porta decoder. Tv-HiFi base shelf in lacquered glass with aluminium structure and cable channelling. TV-HiFi shelf base with bottom shelf for decoder.

Cassetteria sospesa in vetro laccato con struttura in alluminio. / Lacquered glass suspended drawer unit with aluminium structure.

Vetrina sospesa in vetro temperato con ante scorrevoli.  
Suspended showcase in tempered glass with sliding shutters.

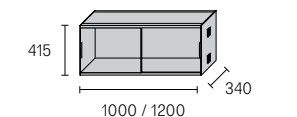
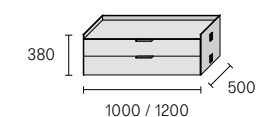
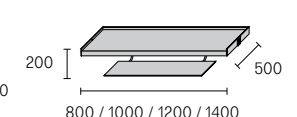



## Finiture Finishings

Struttura e accessori  
Structure and accessories



Ripiano in vetro  
Glass shelf



Cassettiera sospesa e mensolone tv  
Suspended drawer unit and tv top shelf holder



Interno cassetiera  
Internal drawer



Vetrina  
Showcase

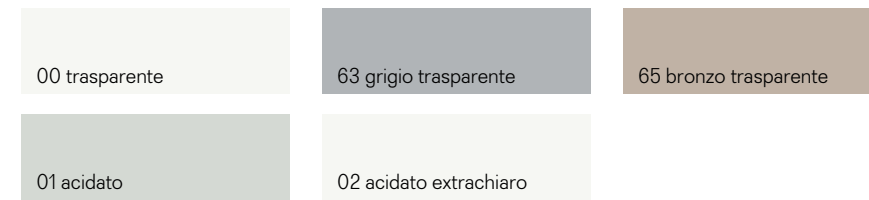



Design Giuseppe Bavuso

## Opus

A modulare bookcase system, entirely in extruded aluminium, based on the free composition of square and rectangle as modular shapes. A rigorous geometric idea which allows to create bookcases of different dimensions with a strong scenographic value. Perfectly double-sided, equipped with drawers or flap doors units, Opus decorates with personality house or professional spaces.

Un sistema libreria componibile, interamente in alluminio estruso, basato sulla libera composizione del quadrato e del rettangolo come figure modulari. Una concezione geometrica rigorosa che consente la definizione di librerie di varie dimensioni dal forte valore scenografico. Perfettamente bifacciale, attrezzabile con contenitori a cassetti o ante a ribalta, Opus si presta ad arredare con personalità ambienti domestici o professionali.

Opus ist ein modulares, komplett aus extrudiertem Aluminium hergestelltes Bücherregalsystem, das auf der freien Zusammenstellung von Quadraten und Rechtecken als modulare Figuren beruht. Es entsteht dadurch ein strenges geometrisches Konzept, das die Definition von Bibliotheken verschiedener Dimensionen mit einem starken szenographischen Wert ermöglicht. Dieses zweiseitige Regal kann mit Schubladen oder Klapptüren ausgestattet werden und eignet sich für die persönliche Einrichtung des Zuhauses oder der beruflichen Umgebung.

Un système de bibliothèque modulaire, entièrement en aluminium extrudé, basé sur la composition libre du carré et du rectangle comme figures modulaires. Un concept géométrique rigoureux qui permet la définition de bibliothèques de différentes dimensions avec une forte valeur scénographique. Parfaitement bifacial, Opus peut être équipé avec de tiroirs ou de portes abatantes, et se prête à l'aménagement des environnements domestiques ou professionnels.

Un sistema modular de librerías, enteramente de aluminio extruido, basado en la composición libre del cuadrado y del rectángulo como figuras modulares. Un concepto geométrico riguroso que permite la definición de librerías de varias dimensiones con un fuerte valor escenográfico. Perfectamente bifacial, puede equiparse con cajones o puertas abatibles, Opus se presta para equipar con personalidad el hogar o entornos profesionales.

Una componibilità virtualmente infinita, da interpretare senza limiti. Il sistema Opus offre la massima libertà dimensionale, per suggerire nuove modalità di progetto degli ambienti. I giunti invisibili ad incastro, in nylon e fibra di vetro, garantiscono la massima stabilità anche in composizioni di grandi dimensioni.

A virtually endless modularity to be interpreted without limits. The Opus system offers the maximum dimensional freedom, in order to suggest new ways to design rooms and environments. The invisible nylon and fiber-glass cushioned joints ensure maximum stability even in very big compositions.

Vollkommen unbegrenzte Kombinationsmöglichkeiten, die sich frei gestalten lassen. Das System Opus bietet eine optimale Freiheit in den Abmessungen und neue Möglichkeiten zur Raumgestaltung. Die unsichtbaren Steckverbindungen aus Nylon und Fiber-Glass garantieren höchste Stabilität bei sehr grossen Kompositionen auch.

Une componibilité virtuellement infinie, à interpréter sans limites. Le système Opus offre une liberté maximale de dimensions, afin de suggérer de nouvelles modalités de projet des espaces. Les joints invisibles à encastrer en nylon et fiber-glass garantissent la plus grande stabilité, même dans des compositions de grande dimension.

Una modularidad virtualmente infinita, que puede interpretarse sin límites. El sistema Opus ofrece la máxima libertad dimensional, para sugerir nuevas modalidades de proyecto de los ambientes. Las juntas invisibles de encastrado en nylon y fibre-glass garantizan la máxima estabilidad incluso en composiciones de grandes dimensiones.



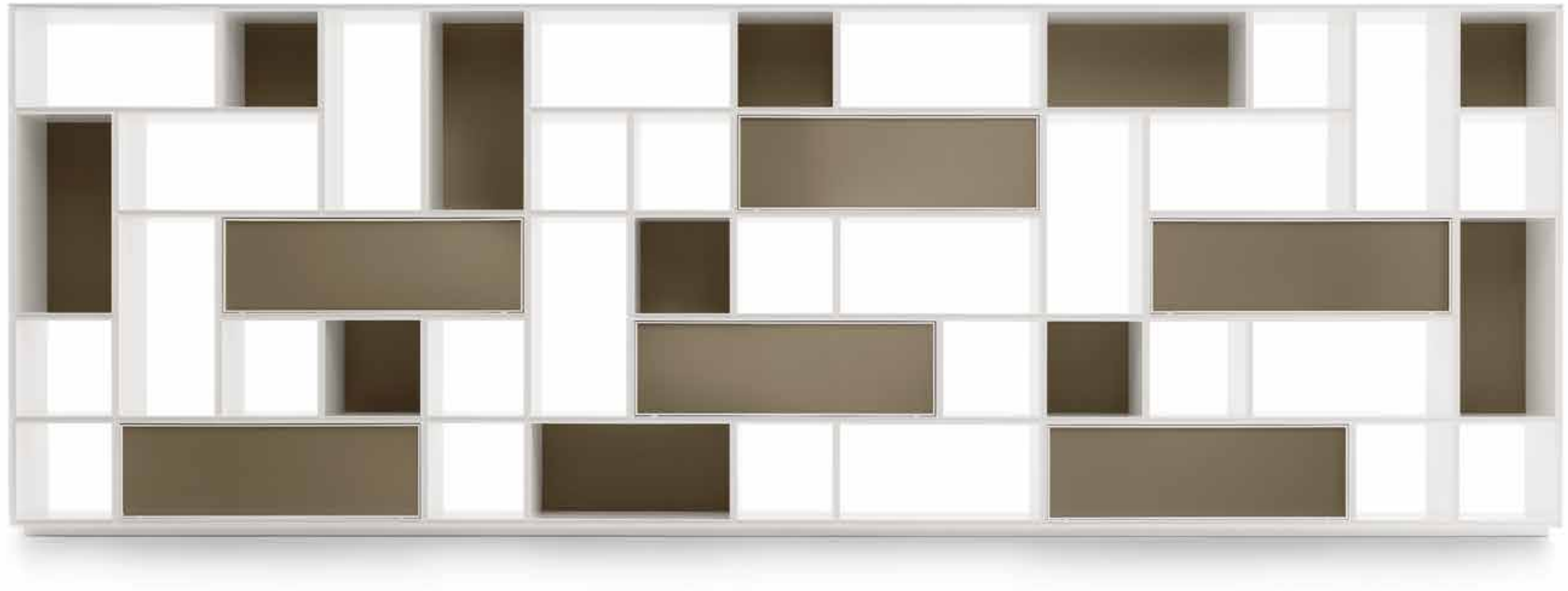



Il sistema Opus offre la massima libertà dimensionale, per suggerire molteplici modalità di progetto degli ambienti. La riduzione delle forme alla semplicità più primaria è il risultato di un'ingegnerizzazione esclusiva: una "qualità invisibile" che costituisce un plus comune a tutte le proposte aziendali. Dalla perfetta giunzione dei moduli, grazie ad agganci ad incastro inseriti all'interno della struttura in alluminio, all'esclusiva anta a ribalta in alluminio e vetro temperato, dotata di cerniere completamente invisibili.

The Opus system offers maximum dimensional freedom thus suggesting multiple project solutions for environments. Shapes reduced to a primary simplicity, this is the outcome of an exclusive production: an "invisibility" that is an added extra of all the company's offers. From the perfect joining of modular units, thanks to joints built into the aluminium frames, to the exclusive flap doors in aluminium and tempered glass, equipped with hinges that cannot be seen at all.

Das System Opus bietet die maximale Massfreiheit, um verschiedene Loesungen fuer das Wohnen vorzuschlagen. Die Verkuerzung der Formen zu der primären Einfachheit ist das Ergebnis einer exklusiven Ingegneurentwicklung: eine "unsichtbare Qualität", die ein Plus für alle Business-Vorschläge ist. Von der perfekten Verbindung der Module durch Haken, in der Alu Struktur integriert, bis zu der exklusiven Klapp-Paneeelen aus Aluminium und gehärtetem Glas, mit völlig unsichtbar Scharnieren ausgeruestet.

Le système Opus offre une liberté dimensionnelle maximale, pour suggérer plusieurs modalités de projet des ambiances. Réduction des formes à une simplicité extrême c'est le résultat des recherches d'ingénierie exclusives: une "qualité invisible" qui est un plus commun à toutes les propositions de l'entreprise. De la parfaite jonction des modules, grâce à l'encliquetage à l'intérieur de la structure en aluminium, à l'exclusive porte abattante en aluminium et verre trempé, dotée de charnières complètement invisibles.

El sistema Opus ofrece la máxima libertad dimensional, para sugerir múltiples modos de diseñar proyectos de los ambientes. La reducción de las formas a la simplicidad más primaria es el resultado de una investigación de ingeniería exclusiva: una "calidad invisible" que constituye un plus común a todas las propuestas de la empresa. De la perfecta unión de los módulos a través de enganches para encajar en el interior de la estructura en aluminio, a la exclusiva puerta abatible en aluminio y cristal templado, con bisagras completamente invisibles.



## Modularità Modular structure

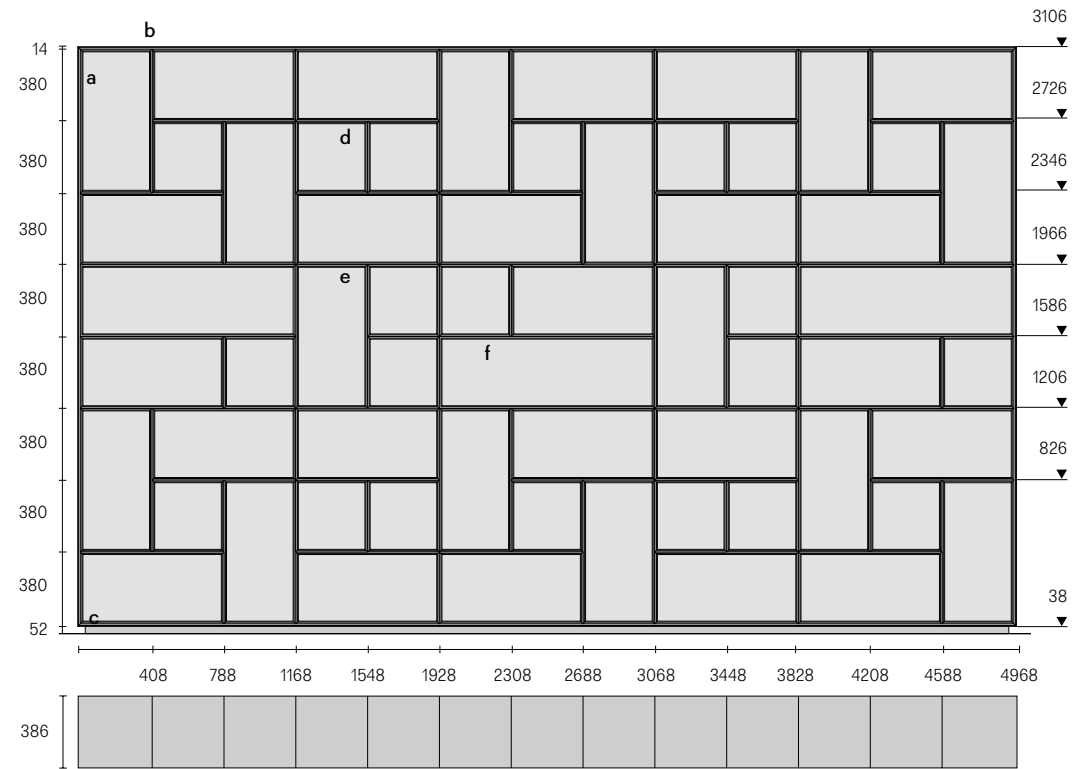

- a. Spalla laterale / Side panel
- b. Top / Top
- c. Basamento / Floor base
- d. Modulo 380 x 380
- e. Modulo 380 x 760
- f. Modulo 380 x 1140

## Descrizione tecnica Technical description

Opus è un sistema libreria componibile, interamente realizzato in alluminio estruso, basato sulla libera composizione del quadrato e del rettangolo come elementi modulari. Una semplicità concettuale che assicura al progetto un'eccezionale versatilità, con la possibilità di realizzare composizioni anche di ampie dimensioni, in assoluta sicurezza. Grazie alla bifaccialità, Opus è in grado di formulare molteplici soluzioni per la definizione architettonica degli ambienti.

Opus is a modular shelving system entirely made in extruded aluminum, based on the free composition of squares and rectangles as modular elements. A conceptual simplicity that ensures exceptional versatility when designing, with the possibility of carrying out even very big compositions in complete safety. Thanks to its two-sided feature, Opus can provide multiple solutions for the architectural definition of environments.

Opus ist ein modulares Regalssystem, komplett fließgeschmiedenes Aluminium, mit der freien Kombination des Quadrats und des Rechtecks als System-Elemente. Die Einfachheit dieses Konzepts bietet eine außerordentliche Planungsvielseitigkeit sowie die Möglichkeit auch sehr große Anlagen in absoluter Sicherheit bauen zu können. Die beidseitige Verwendung ermöglicht freie Erweiterungsmöglichkeiten, um Architektur der Räume definieren zu können.

Opus est un système de bibliothèque à éléments, entièrement réalisé par extrusion d'aluminium, basé sur la libre composition du carré et du rectangle comme éléments composables. Une simplicité de concept qui assure au projet un caractère universel exceptionnel avec la possibilité de réaliser des compositions, même de grandes dimensions, en totale sûreté. Opus, parfaitement bifaciale, permet de proposer plusieurs solutions pour la définition architecturale des ambiances.

Opus es un sistema librería componible, realizado por completo en aluminio extruido, basado sobre la libre composición del cuadrado y del rectángulo como elementos modulares. Una simplicidad conceptual que asegura al proyecto una excepcional versatilidad, con la posibilidad de realizar composiciones también de amplias dimensiones, en absoluta seguridad. Gracias a la bifrontalidad, Opus es capaz de formular múltiples soluciones para la definición arquitectónica de los ambientes.

## Componenti Components



1.

2.

Modulo a giorno in alluminio  
Open module in aluminium

Modulo con cassetti e schienale in vetro  
Module with drawers and glass back

Spalla laterale in alluminio  
Side panels in aluminium

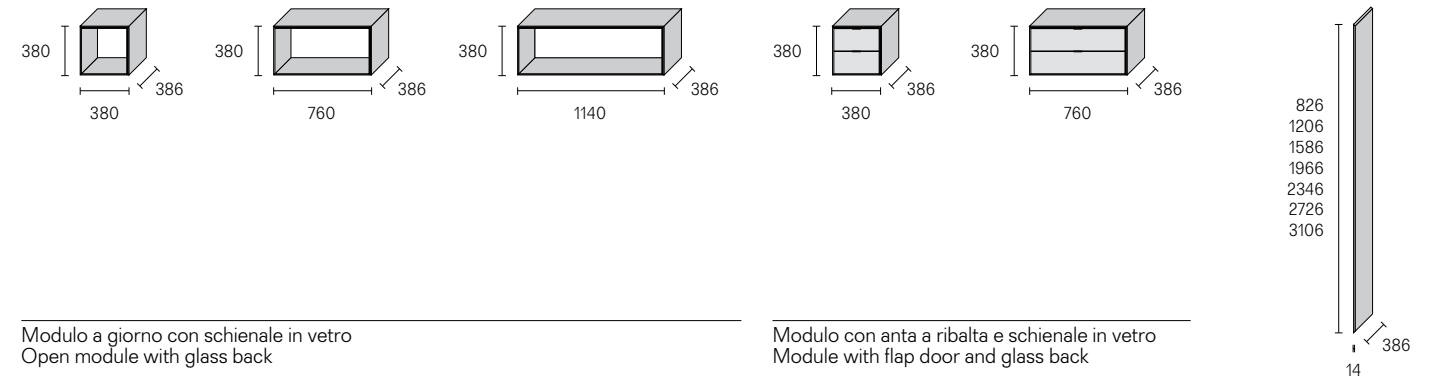

Modulo a giorno con schienale in vetro  
Open module with glass back

Modulo con anta a ribalta e schienale in vetro  
Module with flap door and glass back

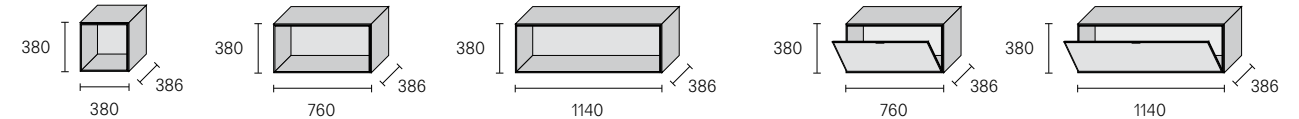

Top in alluminio  
Top in aluminium

Basamento in alluminio  
Base in aluminium

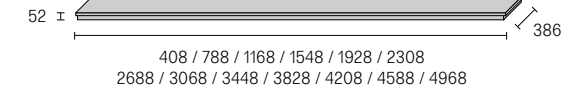
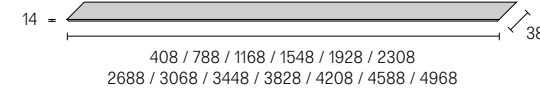

**Tipologie composite**  
**Different compositions**

**Altezza / height 826 mm**

Composizione con moduli a giorno  
 Composition with open module

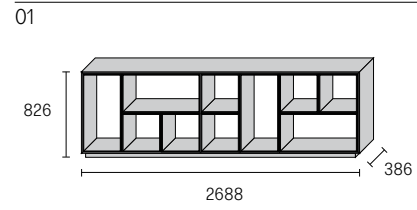

Composizioni con moduli a giorno e ante a ribalta  
 Composition with open module and flap doors

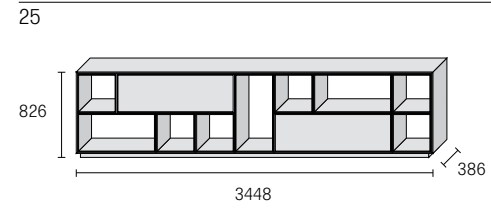

**Altezza / height 1206 mm**

Composizione con moduli a giorno  
 Composition with open module

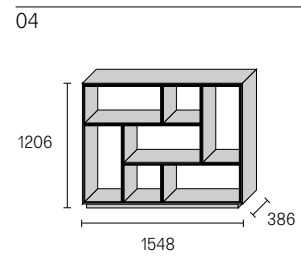
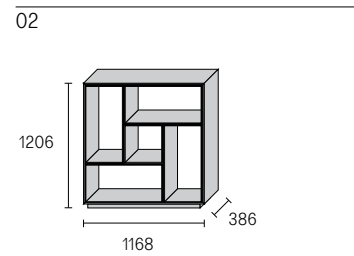

Composizione con moduli a giorno e cassetti  
 Composition with open module and drawers

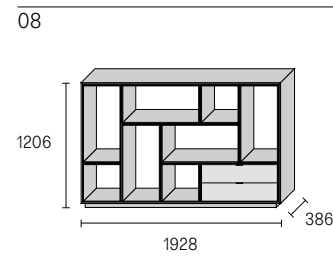
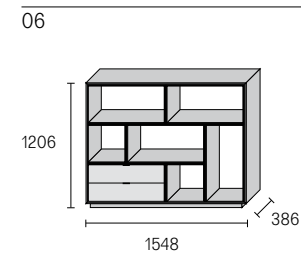

Composizione con moduli a giorno con schienale e cassetti  
 Composition with open modul with back and drawers

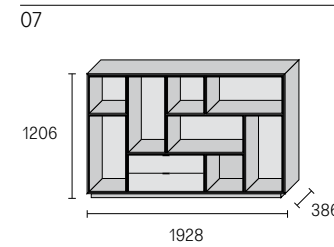
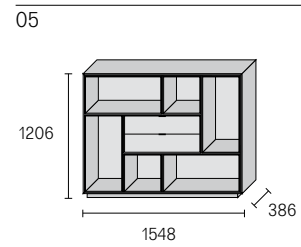
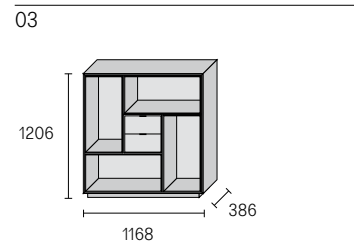

**Altezza / height 1586 mm**

Composizione con moduli a giorno  
 Composition with open module

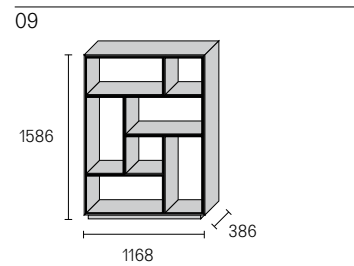

Composizione con moduli a giorno e cassetti  
 Composition with open module and drawers

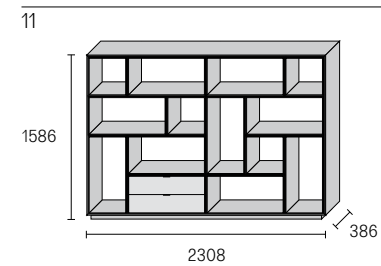

Composizione con moduli a giorno con schienale in vetro e cassetto  
 Composition with open modul with glass back and drawers

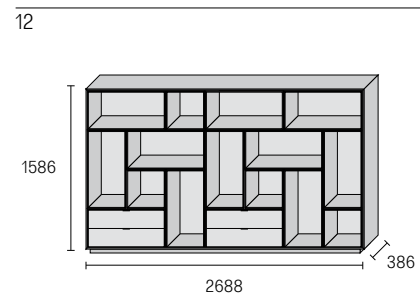
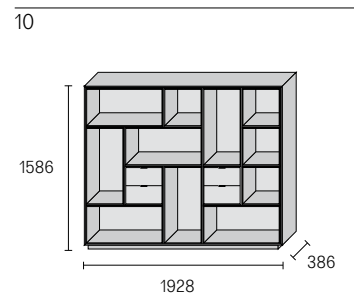

**Altezza / height 1966 mm**

Composizione con moduli a giorno  
 Composition with open module

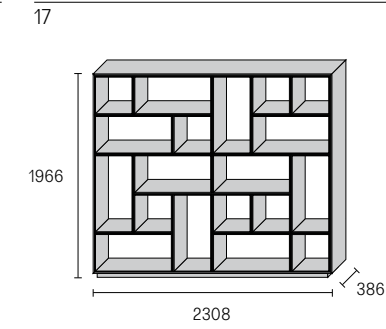
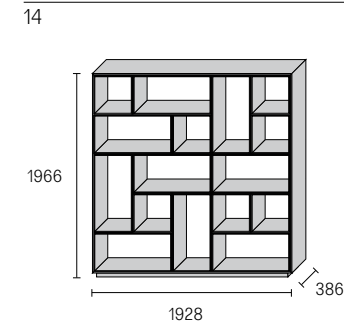

Composizione con moduli a giorno e cassetti  
 Composition with open module and drawers

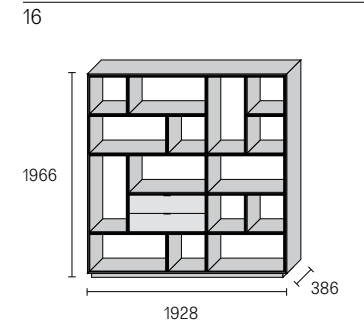

Composizione con moduli a giorno con schienale e cassetti  
 Composition with open modul with back and drawers

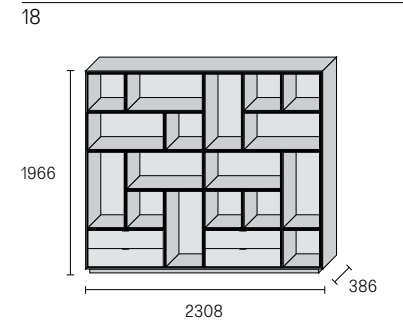
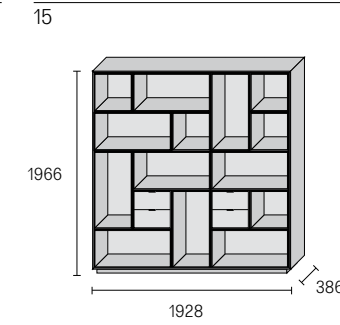
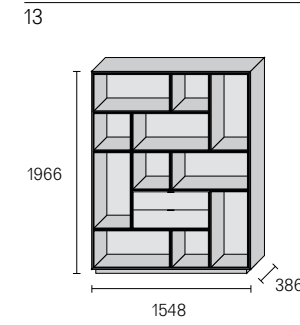

Composizione con moduli a giorno con e senza schienale, cassetti e ante  
 Composition with open modul with back and drawers, flap doors

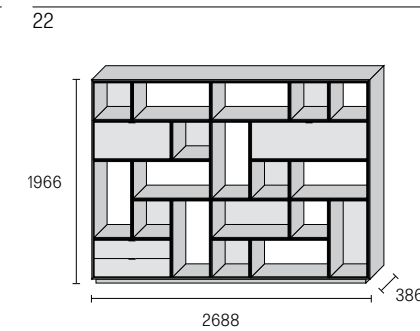
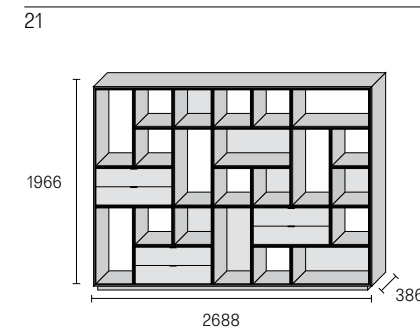

Composizione con moduli a giorno con e senza schienale, ante a ribalta /  
 Composition with open module with or without back and drawers, flap doors

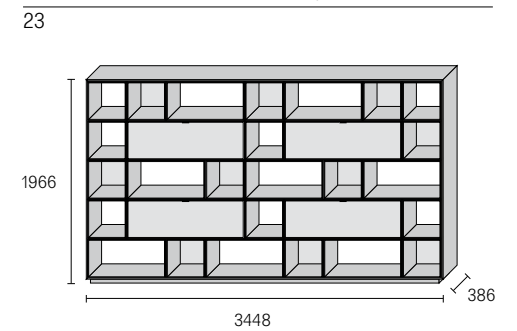

**Altezza / height 2346 mm**

Composizione con moduli a giorno  
 Composition with open module

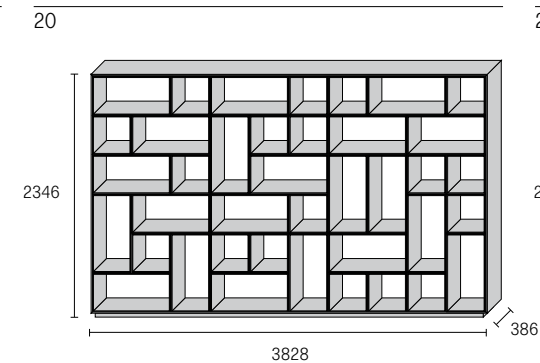
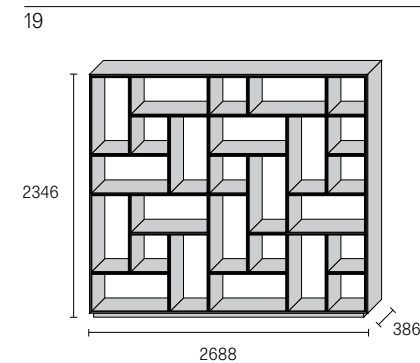

Composizione con moduli a giorno con schienale e ante a ribalta /  
 Composition open module with back and flap doors

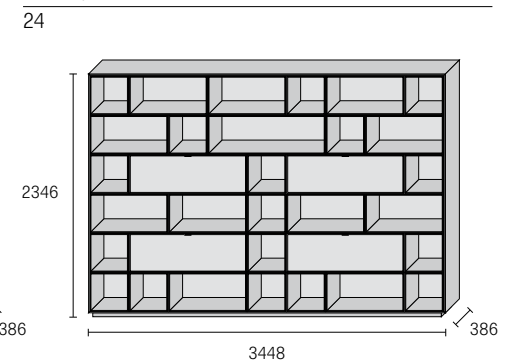

Finiture  
Finishings

Struttura  
Structure



Modulo con cassetti e schienale in vetro  
Module with drawers and glass back panel

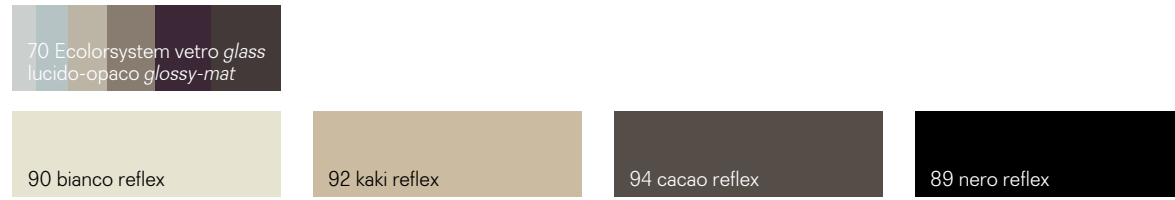

Modulo a giorno con schienale in vetro  
Open module with glass back panel



Modulo con anta a ribalta e schienale in vetro  
Module with flap door and glass back panel



Interno cassettera  
Internal drawer

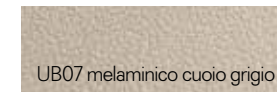





Design Giuseppe Bavuso

## Wind

Wind is the archetype of the bookcase in the new interpretation by Rimadesio: a modular system combining aesthetic lightness and technological innovation. The focus of the project, entirely in aluminium, is represented by the union between extruded shelves and die-casting uprights, in central and terminal versions. Vertical modularity of Wind is obtained by the connection of nylon fibre joints inserted into the uprights which grant the maximum stability. Closing element of each composition is the laminated lacquered mdf top, covered by a double aluminium plate.

Wind è l'archetipo della libreria nella nuova interpretazione Rimadesio: un sistema modulare che coniuga leggerezza estetica e innovazione tecnologica. Il fulcro del progetto, interamente in alluminio, è rappresentato dall'unione fra ripiani estrusi e montanti in pressofusione, in versione centrale e terminale. La componibilità verticale di Wind avviene tramite giunti di collegamento in nylon fibra che si innestano nei montanti e garantiscono la massima stabilità. Elemento terminale di ogni composizione è il top laccato e stratificato in mdf rivestito da una doppia lastra di alluminio.

Wind steht für den neuen Archetyp der Interpretation von Rimadesio: ein modulares System, welches ästhetische Leichtigkeit und technologische Innovation miteinander vereint. Im Mittelpunkt des Projekts steht die Einzigartigkeit der Verbindung aus stranggepressten Profilen der Fachböden und dem aus Aluminiumdruck gegossenen Pfosten. Sowohl in der vertikalen als auch der horizontalen. Die vertikale Komposition von Wind erfolgt durch Verbindungsstücke aus Nylonfaser direkt in den Pfosten, die auch für maximale Stabilität steht. Jede Komposition schließt mit einem aluminiumbezogenem lackiertem Mdf-Sperrholz ab.

Wind est l'archétype de la bibliothèque dans la nouvelle interprétation de Rimadesio: un système modulaire qui combine légèreté esthétique et innovation technologique. Caractéristique du projet, entièrement en aluminium, il est représenté par l'union des étagères extrudées et des montants en moulage d'aluminium en version centrale ou terminale. La modularité verticale de Wind s'effectue par les jonctions de connexion en fibre de nylon qui s'intègrent dans les montants, en assurant une stabilité maximale. L'élément final de chaque composition est le dessus, laqué et stratifié en mdf, revêtu par un double placage d'aluminium.

Wind es el arquetipo de la librería en la nueva interpretación Rimadesio: un sistema modular que combina ligereza estética e innovación tecnológica. El enfoque del proyecto, por completo en aluminio, es representado por la unión entre los estantes extruidos y los montantes en inyección, en versión central y terminal. La modularidad vertical de Wind se lleva a cabo a través de articulaciones de conexión en fibra de nylon que se acoplan en los montantes y garantizan la máxima estabilidad. Elemento terminal de cada composición es el top lacado estratificado en mdf chapado por una hoja doble de aluminio.





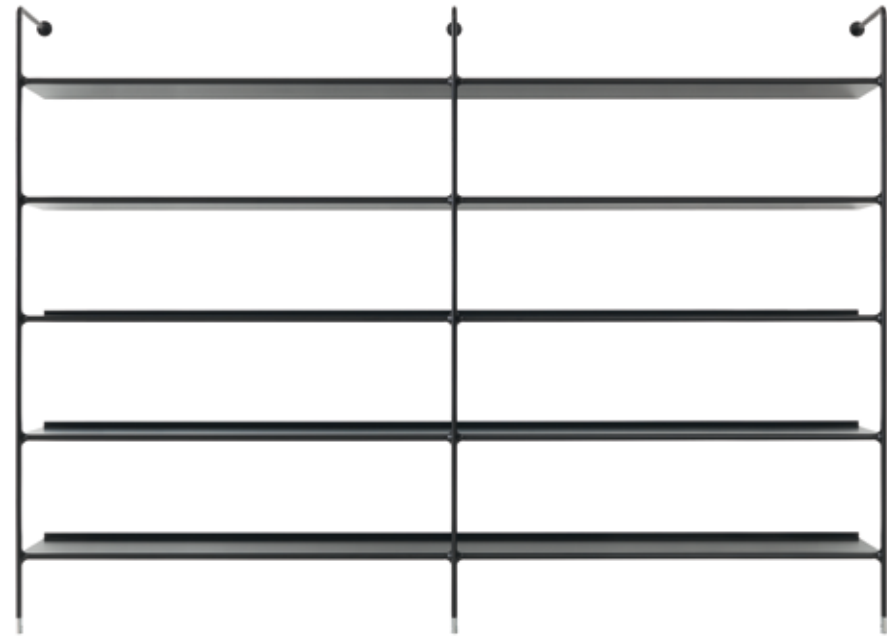

Libreria a parete *Wall bookcase*  
 Struttura *Structure*: 13 nero  
 W 2420 H 2018 D 400

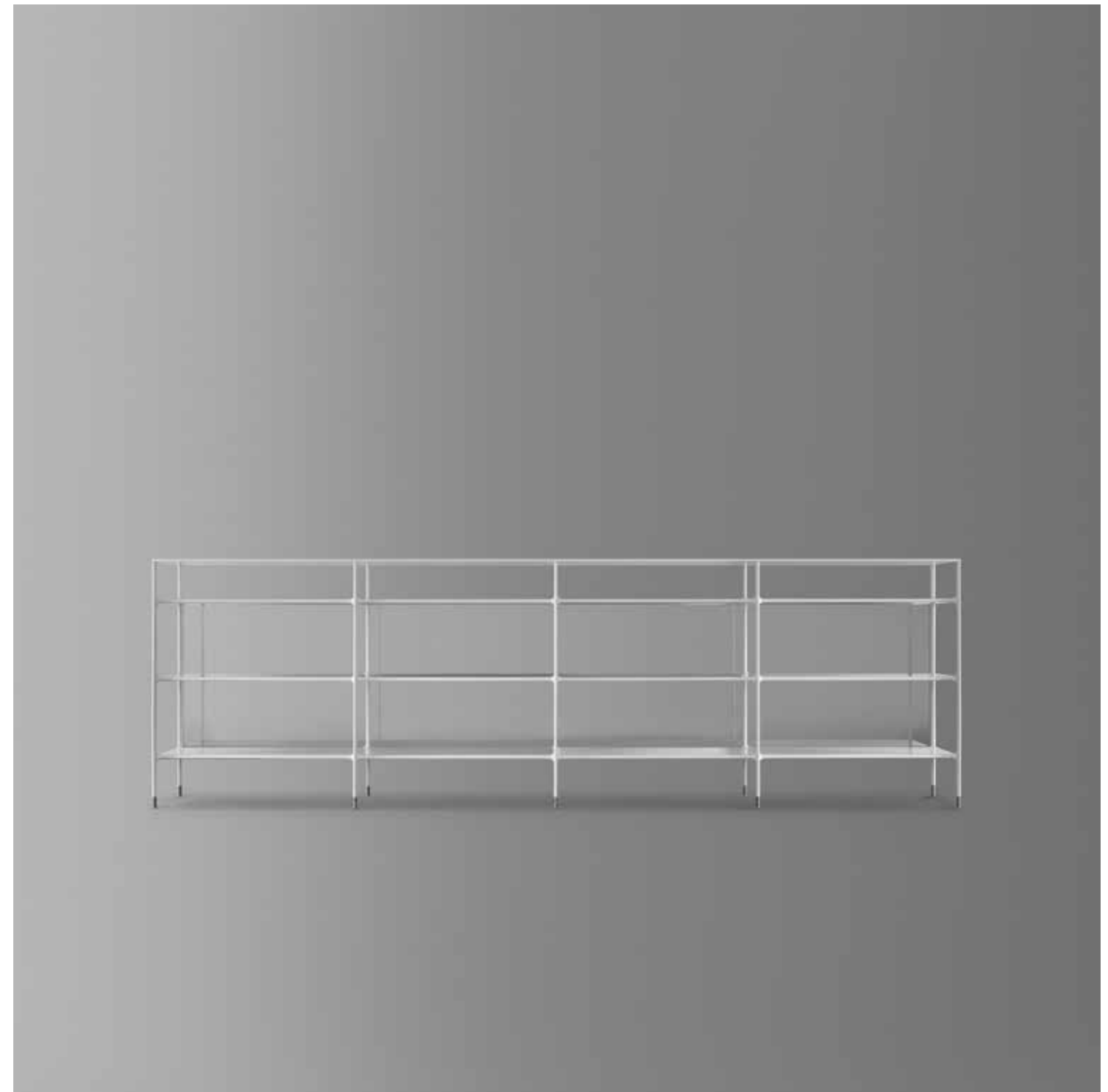

Libreria freestanding *Freestanding bookcase*  
 Struttura *Structure*: 16 bianco latte  
 Schienale in vetro *Glass back panel*: 01 acidato  
 W 4020 H 1202 D 400









**Modularità**  
Modular structure

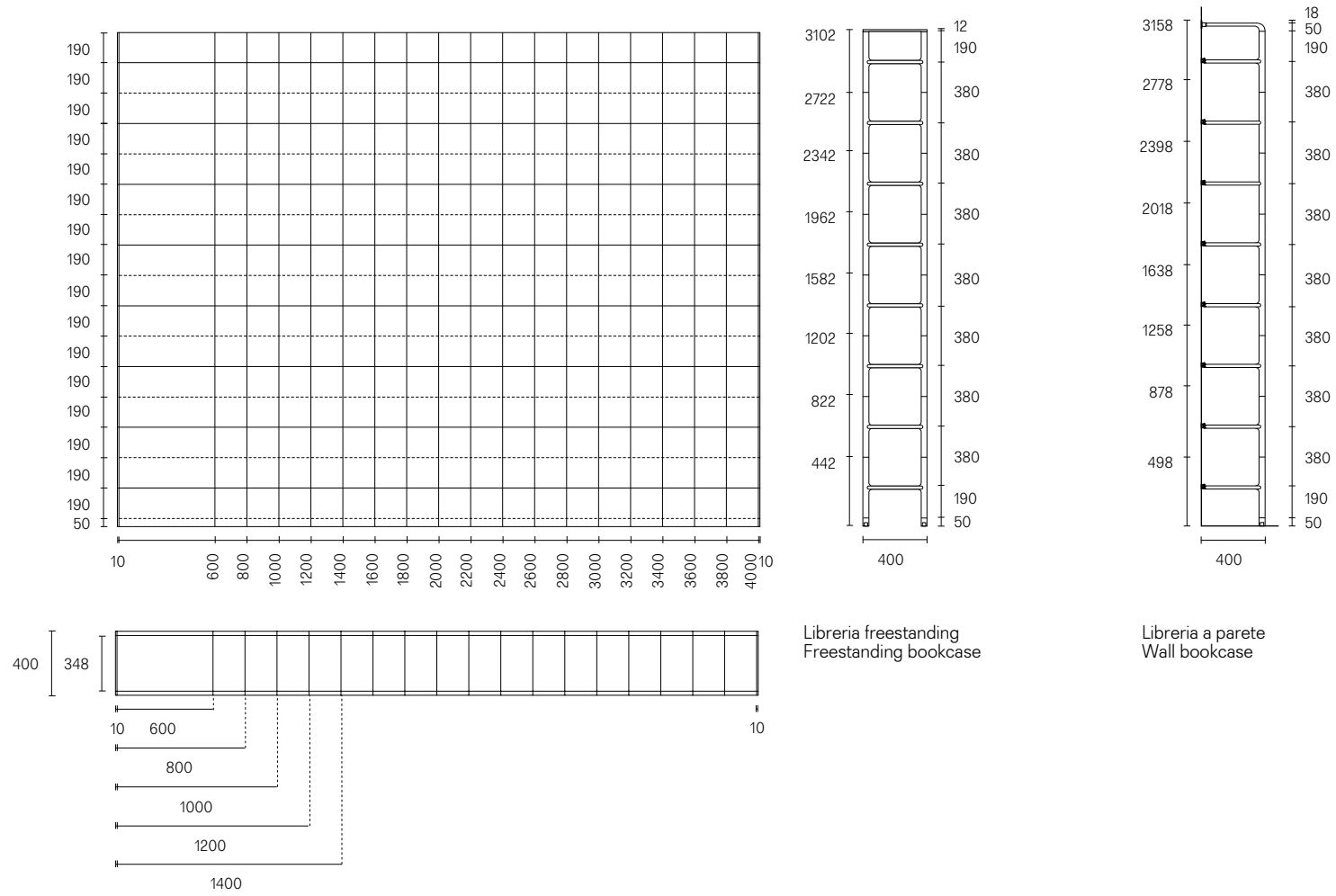

Libreria freestanding  
Freestanding bookcase

Libreria a parete  
Wall bookcase

**Descrizione tecnica**  
Technical description

Prevista in 5 larghezze e 7 altezze, la libreria Wind è disponibile nelle finiture alluminio brown, nero, bianco latte, nei 34 colori laccati della gamma Ecolorsystem, oltre alle 5 finiture con effetto spazzolato. Tutte le finiture sono realizzate con vernici idrosolubili di ultima generazione.

Wind bookcase is available in 5 widths and 7 heights, in brown, black, bianco latte, 34 Ecolorsystem lacquered colours and 5 brushed aluminium finishes. All finishes are obtained from water paints of latest generation.

Wind ist verfügbar mit 5 Breiten, 7 Höhen und Alu Struktur Ausführung brown, schwarz, bianco latte, 34 lackierte Farbe von Ecolorsystemkollektion sowie 5 gebürstete Versionen. Alle die Ausführungen sind Absolut oekologische Farben, und sind die modernsten verfügbaren Lackierungen.

La bibliothèque Wind est disponible en 5 largeurs et 7 hauteurs dans les finitions en aluminium brown, nero, bianco latte, laquée dans les 34 couleurs de la gamme Ecolorsystem, en plus de cinq finitions brossées. Toutes les finitions sont réalisées avec la dernière génération de peintures hydrosolubles.

Prevista en 5 anchuras y 7 alturas, la libreria Wind es disponible en los acabados aluminio brown, negro, bianco latte, en los 34 colores lacados de la gama Ecolorsystem, además de los 5 acabados con efecto cepillado. Todos los acabados están realizados con pinturas hidrosolubles de última generación.

**Componenti**  
Components



1. Contenitore a due cassetti: fianchi, schienale e frontale cassetti in vetro laccato. Cassetti in alluminio con apertura push e guide ad estrazione totale. / Two drawer-unit: Sides, back panel and front in lacquered glass. Drawers in glossy aluminium with push and pull opening and totally extractable runners.
2. Contenitore bar con anta a ribalta, schienale interno in specchio grigio e ripiano in vetro trasparente extraclear. / Bar unit with flap door, internal back panel in grey mirror and shelf in transparent extraclear glass.
3. Dettaglio del raccordo fra ripiano in alluminio estruso e montante in alluminio pressofuso, in versione centrale e terminale. / Detail of the junction between the extruded aluminium profile and the die-casting aluminium upright, terminal and central version.
4. Lo schienale in vetro temperato è dotato di un esclusivo sistema d'aggancio, ed è disponibile in un'ampia varietà di finiture. / The backpanel in tempered glass is equipped with an exclusive hanging system, and it is available in a wide range of finishes.

Top in mdf laccato e stratificato, rivestito da una doppia lastra di alluminio / Laminated lacquered mdf top, covered by a double aluminium plate

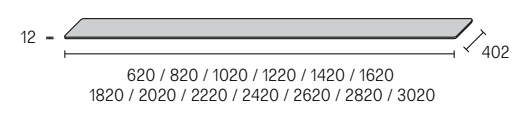

Ripiano in alluminio con profili estrusi di chiusura / Aluminium shelf with extruded closing profiles

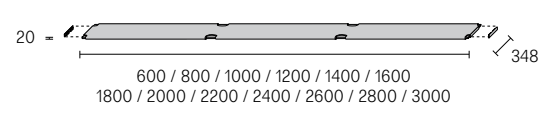

Schienali in vetro temperato / Backs in tempered glass

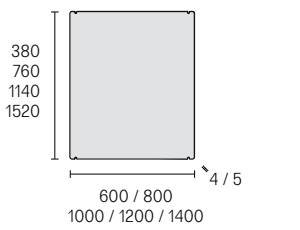

Montanti terminali e centrali in pressofusione di alluminio / Terminal and central uprights in die-casting aluminium



Montante per vani a doppia altezza / Upright for double-height openings



Supporti per ripiano a parete / Wall shelf brackets

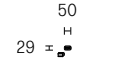

Staffa superiore a parete / Upper wall bracket

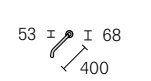

Piedino regolabile / Adjustable foot

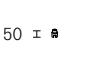

Modulo a giorno in lamiera laccata / Open module in lacquered sheet metal

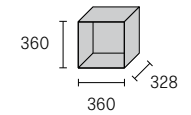

Cassettiera con 2 cassetti push / Drawer unit with 2 push drawers

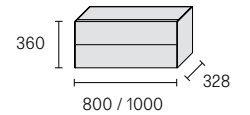

Contenitore con anta a ribalta / Flap door cabinet

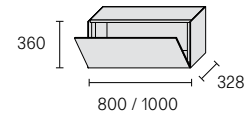

Contenitore bar con anta a ribalta / Bar cabinet with flap door

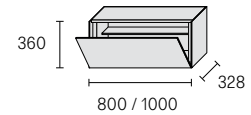

Porta decoder per vano TV / Decoder support for TV compartment

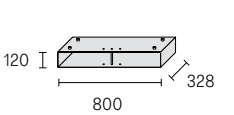

**Finiture**  
**Finishings**

Struttura, top, ripiano e staffa  
Structure, top, shelf and bracket



Modulo a giorno  
Open module

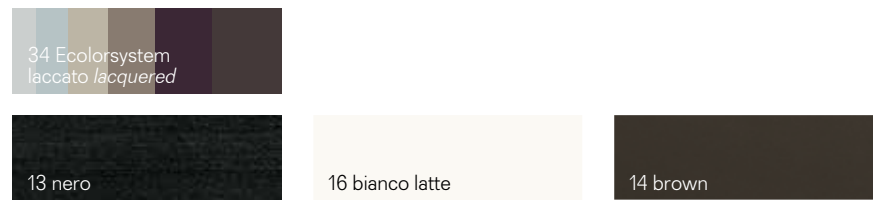

Cassettiera e contenitore anta a ribalta  
Drawer unit and flap door unit

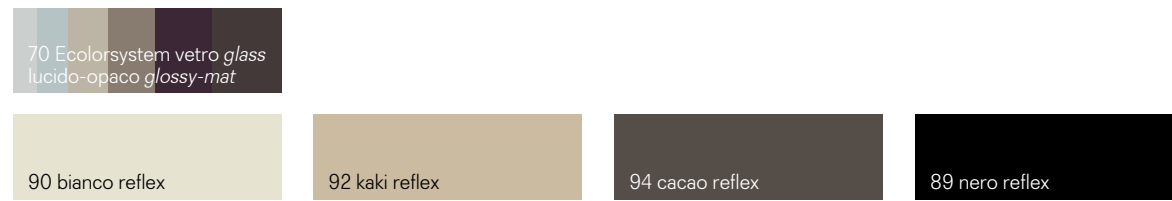

Profili cassetto e anta a ribalta  
Drawer profile and flap door



Interno contenitore e cassetteria  
Internal unit and drawer



Sponde cassetto  
Drawer runners



Schienale  
Back panel

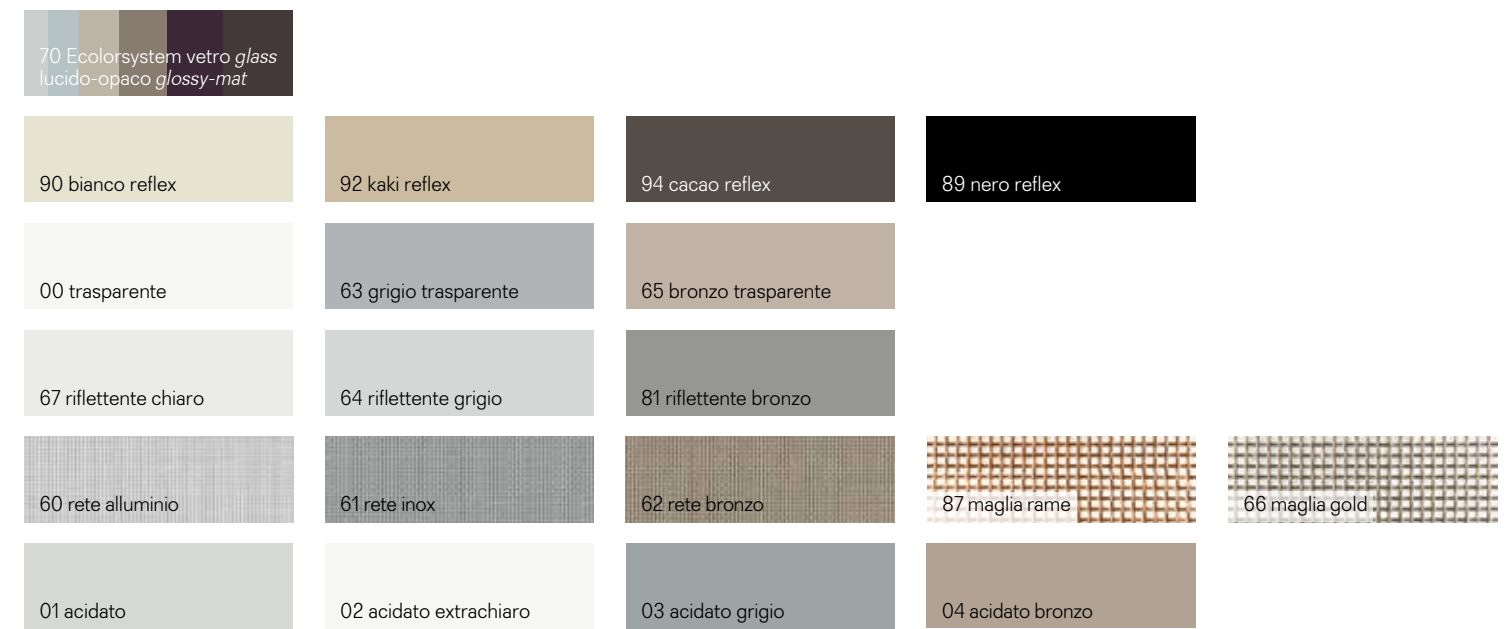

# Storage unit systems



58 Alambra, 102 Self, 116 Self bold, 134 Self up,  
160 Abacus living



Design Giuseppe Bavuso

## Alambra

With Alambra, Rimadesio gives a contemporary reinterpretation of classic furniture like sideboards, glass cabinets and drawer units. A collection characterized by the particular structure in aluminum, by exclusive design details, by the mechanisms of movement and by shelves equipped with integrated led lighting system. A proposal available in different sizes and with different technical internal equipment.

Con Alambra, Rimadesio propone una reinterpretazione in chiave contemporanea di tipologie classiche dell'arredo come madie, vetrine e cassettiere. Una collezione caratterizzata dalla particolare struttura in alluminio, dal disegno esclusivo dei dettagli, dai meccanismi di movimento e dotata di illuminazione a led integrata nei ripiani. Una proposta articolata in varie dimensioni e dotata di attrezzature tecniche differenziate.

Mit Alambra bietet Rimadesio eine gemäßige Neuinterpretation den klassischen Möbeltypen wie Sideboard, Vitrine und Schubladen Elementen an. Eine Kollektion von der besonderer Struktur aus Aluminium charakterisiert, exklusive Design-Details, Mechanismen der Bewegung und Led-Beleuchtung integriert bei Fachböden. Einer artikulierter Vorschlag in verschiedenen Massen und mit differenzierten technischen Ausrüstungen.

Avec Alambra, Rimadesio propose une réinterprétation contemporaine de meubles comme les bahuts, les vitrines et les blocs tiroirs. Une collection caractérisée par une particulière structure en aluminium, par des détails exclusifs de design, par mécanismes de mouvement et équipée de système d'éclairage à led intégré dans les étagères. Une proposition disponible en différentes dimensions et avec équipements différents.

Con Alambra, Rimadesio ofrece una reinterpretación contemporánea de tipologías clásicas de mobiliario como aparadores, vitrinas y cajoneras. Una colección que se caracteriza por la estructura particular en aluminio, de diseño exclusivo de los detalles, de los mecanismos de movimiento y dotata de iluminación por leds integrada en los estantes. Una propuesta que se articula en varios tamaños y con equipo técnico diferentes.

Monetiere Monetiere  
Struttura Structure: 303 bronzo  
Vetro Glass: 81 riflettente bronzo  
Cassetti e basamento Drawers and floor base: 15 noce  
W 1008 H 1553 D 500

Nella foto In this photo  
Pannelli scorrevoli  
Sliding doors: Graphis plus  
Cabina Armadio  
Walk-in closet: Dress Bold



Monetiere *Monetiere*  
Struttura *Structure*: 303 bronzo  
Vetro *Glass*: 81 riflettente bronzo  
Cassetti e basamento *Drawers and floor base*: 15 noce  
W 1008 H 1553 D 500





Il versione Alambra bar è un mobile con frigorifero interno, dotato di vani a giorno ed anta in noce, top e maniglia in similpelle castoro. In dotazione anche quattro vassoi rivestiti in similpelle castoro. È previsto inoltre un sistema illuminazione a led integrato.

The Alambra bar version is a unit with internal fridge, equipped with open compartments and door in walnut, top and handle in castoro synthetic leather. Four trays in castoro synthetic leather are also supplied. It can be equipped with an integrated led lighting system.

Die Alambra Bar Version ist ein Möbel mit internem Kühlschrank ausgestattet mit offenen Fächern und Türen in Nussbaum, Top und Griff aus Kunstleder castoro. Lieferbar mit vier Tablett aus Kunstleder castoro bedeckt. Ein integriertes Led-Beleuchtungssystem ist ebenfalls vorhanden.

La version Alambra bar est un meuble avec réfrigérateur interne, équipé de compartiments ouverts et une porte en noyer, le plateau et la poignée en simili-cuir castoro. Quatre plateaux recouverts de simili-cuir castoro sont également fournis. Un système d'éclairage led intégré est également fourni.

La versión de Alambra bar es un mueble con refrigerador interno, equipado con módulos abiertos y puerta en nogal, top y manilla en simil cuero castoro. Se suministra con cuatro bandejas cubiertas en simil cuero castoro. Además está previsto un sistema de iluminación led integrado.











Struttura *Structure*: 13 nero  
 Vetro *Glass*: 63 trasparente grigio  
 Cassettiere *Drawers*: 27 rovere nero  
 Schienale *Back*: 73 giallo kashmir lucido  
 Interno cassetti *Internal drawers*: 153 similpelle castoro  
 W 1308 H 1659 D 500



Architettura e arredo si integrano con armonia, suggerendo spazi domestici essenziali e rigorosi. Questa è la filosofia alla base del progetto Alambra, caratterizzato dal particolare disegno delle ante, comune al sistema di porte scorrevoli Stripe e alla porta battente e scorrevole Even. Il design di Alambra riduce al minimo gli spessori strutturali in alluminio, lasciando che il vetro trasparente e il sistema di illuminazione a led integrato nei ripiani valorizzi al massimo gli oggetti esposti.

Architecture and interior design are harmoniously integrated, thus suggesting essential and rigorous domestic spaces. This is the philosophy behind the Alambra project, characterized by its particular design of the doors, the same of the sliding panel system Stripe and the swing and sliding door Even. The Alambra design minimizes the aluminum structural thickness, thus maximizing the clear glass and the led lighting system, which is built into the shelves.

Architektur und Möbeln mit Harmonie sich einbinden, und hindeuten wesentlichere und strengere Wohnräume. Das ist die Philosophie hinter dem Projekt Alambra, gekennzeichnet von besonderen Design der Türen, wie bei Schiebetüren System Stripe und Even Tür. Das Design Alambra reduziert die Strukturstärken des Aluminiums auf ein Minimum. Das transparente Glas und die Led Beleuchtung in den Böden bringen die ausgestellten Gegenstände voll zur Geltung.

Architecture et décoration d'intérieurs sont intégrés harmonieusement et créent espaces domestiques essentiels et rigoureux. C'est bien la philosophie du projet Alambra, caractérisé par le dessin des portes, le même des panneaux coulissants Stripe et de la porte battante ou à galandage Even. Le design de Alambra minimise l'épaisseur de la structure aluminium, laissant que le verre transparent et le système d'éclairage à led intégré dans les étagères mettent en valeur les objets exposés.

Arquitectura y mobiliario se mezclan armoniosamente, sugiriendo espacios domésticos esenciales y rigurosos. Esta es la filosofía detrás del proyecto Alambra, que se caracteriza por el diseño particular de las puertas, común al sistema de paneles correderos Stripe y a la puerta batiente y corredera Even. El design de Alambra minimiza el grosor de la estructura de aluminio, dejando que el vidrio transparente y el sistema de iluminación por led integrado en los estantes maximice los objetos expuestos.



Struttura Structure: 13 nero  
Ante e ripiani Doors and shelves: 63 grigio trasparente  
Fianchi e schienale Sides and back panel: 64 riflettente grigio  
W 2616 H 1516 D 500





Struttura *Structure*: 13 nero  
 Ante *Doors*: 63 trasparente grigio  
 Fianchi e schienali *Side and back panels*: 64 riflettente grigio  
 Top *Top*: 102 nero opaco  
 Cassetti *Drawers*: 27 rovere nero  
 Interno cassetti *Internal drawers*: 153 similpelle castoro  
 W 2616 H 833 D 500



Struttura *Structure*: 14 brown  
 Vetro *Glass*: 03 acidato grigio  
 Top *Top*: 99 caffè opaco  
 Cassetti *Drawers*: 19 rovere termotrattato  
 Ripiano interno *Internal shelf*: 63 trasparente grigio  
 W 2616 H 833 D 500











Mobile espositore centrostanza *Middle room display unit*  
 Struttura e base *Structure and base*: 303 bronzo  
 Vetro *Glass*: 67 riflettente chiaro  
 Cassetti *Drawers*: 15 noce  
 Interno cassetti *Drawer internal lining*: 153 similpelle castoro  
 Schienale interno *Internal back*: 68 specchio grigio  
 Ripiani in vetro *Glass shelves*: 63 grigio trasparente  
 W 2016 H 833 D 939

Il sistema Alambra si arricchisce di due nuove proposte con piano in vetro trasparente: in versione madia con diverse attrezzature e in versione contenitore centrostanza.

The Alambra system expands with two new proposals with transparent glass top: in the sideboard version with different equipment and in the freestanding cabinet version.

Das Alambra-System wird mit zwei neuen Vorschlägen mit transparenter Glasplatte bereichert: in der Sideboard-Version mit unterschiedlicher Ausstattung und in der zentralen Container-Version.

Le système Alambra est enrichi avec deux nouvelles propositions avec le plateau en verre transparent: dans la version bahut avec deux équipements différents et dans la version îlot central.

El sistema Alambra se enriquece de dos nuevas propuestas con top en cristal transparente: en la versión de aparador con diferentes equipos y en la versión de contenedor central.



Mobile espositore centrostanza *Middle room display unit*  
Struttura e base *Structure and base*: 303 bronzo  
Vetro *Glass*: 67 riflettente chiaro  
Cassetti *Drawers*: 15 noce  
Interno cassetti *Drawer internal lining*: 153 similpelle castoro  
Schienale interno *Internal back*: 68 specchio grigio  
Ripiani in vetro *Glass shelves*: 63 grigio trasparente





Libreria *Bookcase*  
 Struttura *Structure*: 83 piombo  
 Top e basamento *Top and floor base*: 33 verde oliva  
 Schienale e cassetti in vetro *Glass back and drawers*: 33 verde oliva lucido  
 Ripiani e fianchi *Shelves and side panels*: 63 grigio trasparente  
 Ripiano strutturale e interno cassetti  
*Structural shelf and internal drawers*: 154 similpelle argilla  
 W 1308 H 1576 D 400



Libreria *Bookcase*  
 Struttura *Structure*: 14 brown  
 Top e basamento *Top and floor base*: 75 amaranto  
 Schienale e cassetti in vetro *Glass back panel and drawers*: 75 amaranto lucido  
 Ripiani e fianchi *Shelves and sides*: 63 grigio trasparente  
 Ripiano strutturale e interno cassetti *Structural shelf and internal drawers*: 153 similpelle castoro  
 W 1948 H 1900 D 400

Versioni libreria con vani a giorno disponibili in due altezze e due larghezze. Una collezione caratterizzata dalla presenza nella parte centrale di cassetti con apertura push, dalla combinazione tra le finiture esclusive di vetro laccato, similpelle e alluminio, dalla disponibilità di illuminazione a led, dalla versione bifacciale.

A bookcase version with open modules available in two heights and two widths. A collection characterized by the presence of push open drawers in the central part, by the combination of exclusive glass lacquered finishings, synthetic leather and aluminum, by the possibility to be equipped with led lighting system and by the double sided version.

Ein Buecherregal mit offenen Faechern in zwei verschiedenen Hoehen und zwei Breiten anbietet. Charakteristisch sind die Schubladen mit Push-Pull Oeffnung mittig im Buecherregal, exklusive Kombinationen von verschiedenen lackierten Gläser, der Einsatz von Leder, Aluminium, die Ledbeleuchtung und die Moeglichkeit als Raumteiler eingesetzt zu werden.

Propositions bibliothèque avec niches ouvertes, disponibles en deux hauteurs et deux largeurs. Une collection caractérisée par la présence, dans la partie centrale, de tiroirs avec ouverture à pression et combinaison de finitions exclusives de verre laqué, simili-cuir castoro et aluminium, avec possibilité de l'éclairage led et version double face.

Las versiones librería con módulos abiertos disponibles en dos alturas y dos anchuras. Una colección caracterizada por la presencia en la parte central de cajones a empuje, de la combinación entre de cristal lacado acabados exclusivos, simil cuero y aluminio, de la disponibilidad de la iluminación led, de la versión bifacial.



Libreria Bookcase  
Struttura Structure: 14 brown  
Top e basamento Top and floor base: 75 amaranto  
Schienale e cassetti in vetro Glass back panel and drawers: 75 amaranto lucido  
Ripiani e fianchi Shelves and sides: 63 grigio trasparente  
Ripiano strutturale e interno cassetti Structural shelf and internal drawers: 153 similpelle castoro







La vetrina pensile è dotata di un esclusivo meccanismo invisibile per l'apertura dell'anta ribalta, specificatamente progettato per questa raffinata versione a parete, frutto della ricerca tecnologica Rimadesio.  
L'illuminazione led di ultima generazione è incassata nei profili orizzontali in alluminio.

The suspended display case is equipped with an exclusive invisible mechanism for the opening of the flap door, specifically designed for this refined wall version, the result of Rimadesio's technological research.  
The led lighting system of latest generation is embedded in the horizontal aluminum profiles.

Die Hängevitrine ist mit einem exklusiven unsichtbaren Mechanismus für das Öffnen der Klapptür ausgestattet. Letzterer ist das Ergebnis der technologischen Forschung Rimadesios, das speziell für diese raffinierte Wandversion ausgelegt ist.  
Die Led-Beleuchtung der neuesten Generation ist in die horizontalen Aluminiumprofile eingebettet.

La vitrine suspendue est équipée d'un exclusif mécanisme invisible pour l'ouverture de la porte abattante, spécialement conçu pour cette version murale raffinée, comme résultat de la recherche technologique Rimadesio.  
L'éclairage led de dernière génération est intégré dans les profilés horizontaux en aluminium.

La vitrina colgante está equipada de un exclusivo mecanismo invisible para la apertura de la puerta abatible, específicamente diseñado para esta versión refinada a pared, resultado de la investigación tecnológica de Rimadesio. La iluminación led de última generación está integrada en los perfiles horizontales en aluminio.



Vetrina pensile con anta a ribalta  
Suspended cabinet with flap door  
Struttura Structure: 303 bronzo  
Anta, fianchi e top Door, sides and top: 67 riflettente chiaro  
Top interno Internal top: 303 bronzo lucido  
Schienale Back: 68 specchio grigio  
W 1403 H 386 D 316



Vetrina pensile con anta battente *Suspended cabinet with hinged door*  
 Struttura *Structure*: 303 bronzo  
 Anta e fianchi *Door and side panels glass*: 67 riflettente chiaro  
 Schienale *Back panel*: 68 specchio grigio  
 Ripiani *Shelves*: 63 grigio trasparente  
 Cassetto interno *Internal drawer*: 15 noce  
 Top e fondo cassetto *Top and lining drawer*: 153 similpelle castoro  
 W 424 H 1604 D 338



## Le caratteristiche tecniche esclusive Exclusive technical properties

Sistema di chiusura standard  
Standards closing system



In alternativa alla maniglia in pressofusione di alluminio, l'anta può essere dotata di una serratura opzionale, appositamente progettata per garantire sicurezza e precisione nel rispetto di una estetica essenziale e raffinata. Ogni componente, chiave, nottolino e levetta sono ottenuti attraverso lo stampaggio ad alta pressione e previsti in finitura uniforme alla struttura.

As an alternative to die-casting aluminum handle, the door can be provided with an optional lock, designed to guarantee security and precision, respecting the linear and elegant aesthetics. Each component, key, tumbler and lever are obtained thanks to high-pressure moulding and provided in the same finish of the structure.

Sistema di chiusura con nottolino  
Closing system with tumbler



Als Alternative zum Griff aus stranggepresstem Aluminium, besteht optional die Möglichkeit ein Schloss zu bekommen. Jede Komponente, Schlüsselsel, Schloss und Hebel werden durch unter Hochdruck in Form gepresst und sind in den Strukturfarben erhältlich.

Comme alternative à la poignée en aluminium moulé sous pression, la porte peut être équipée d'une serrure en option, spécialement conçue pour assurer sécurité et précision en respectant son aspect essentiel et raffiné. Chaque composant, clé, serrure et petit levier sont obtenus par un moulage à haute pression et fournis dans une finition similaire à la structure.

Como alternativa a la fundido a presión mango de aluminio, la puerta se puede equipar con un bloqueo opcional, especialmente diseñado para garantizar la seguridad y la precisión con respecto a un aspecto esencial y refinado. Cada componente, llave, cerradura y la palanca se obtienen a través del moldeo de alta presión y dentro de un acabado uniforme a la estructura.

Anta  
Door



Disponibile con o senza traversini, interamente realizzata in alluminio estruso, l'anta di Alambra è un progetto in cui si concentra l'attenzione al dettaglio tipica della proposta Rimadesio. La precisione del movimento di apertura, l'innovazione introdotta dal sistema di chiusura con magneti in neodimio, la silenziosità ottenuta grazie ai gommini ammortizzatori regolabili, la totale assenza di viti, giunzioni e guarnizioni in plastica sono il risultato di una ricerca tecnica esclusiva.

Available with or without cross-pieces, entirely made in extruded aluminum, the project of Alambra door is focusing the attention on details, typical of all Rimadesio proposals. The precision of the opening movement, the innovation introduced by the closing system with neodymium magnets, the noise absence obtained by adjustable rubber bulb absorber, the absence of visible screws, joints and plastic gaskets are the results of an exclusive technical research.

Die Tür von Alambra aus extrudiertem Aluminium ist mit oder ohne Sprossen erhältlich. Rimadesio konzentriert sich auch auf Details. Die Genauigkeit der Öffnung der Tür, die Innovation der Schliessung mit Magneten in Neodym, die Geräuschlosigkeit durch adjustable Gummidämpfer, keine Sichtschrauben und Verbindungsteile aus Kunststoff sind das Ergebnis der exklusiven technischen Forschung die her bei Firma Rimadesio gemacht wurde.

La porte de Alambra, disponible avec ou sans traverses, entièrement en aluminium extrudé, est un projet dédié à l'attention du détail, caractéristique commune à toutes les propositions Rimadesio. La précision du mouvement d'ouverture, la nouveauté introduite par le système de fermeture avec des aimants de néodyme, l'absence du bruit obtenue grâce aux amortisseurs réglables en caoutchouc, et l'absence totale de vis et joints en plastique, même à son intérieur, sont également le résultat d'une recherche technique très exclusive.

Disponibile con o sin travesaños, hecha enteramente en aluminio extruido, la puerta de Alambra es un proyecto en que se centra la atención al detalle típica de la propuesta Rimadesio. La precisión del movimiento de apertura, la innovación introducida por el sistema de cierre con imanes de neodimio, la silenziosidad obtenida gracias a las gomas amortiguadoras ajustables, la total ausencia de tornillos, juntas y gomas también en el interior son el resultado de una búsqueda técnica exclusiva.

## Tipologie estetiche Aesthetical typologies

Monetiere  
Monetiere

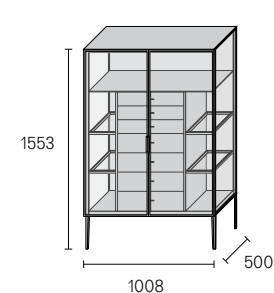

Mobile bar  
Bar cabinet

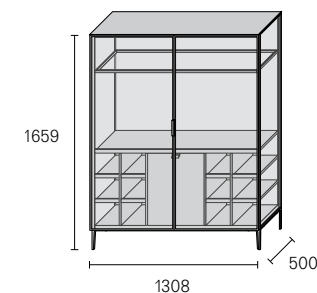

Libreria  
Bookcase

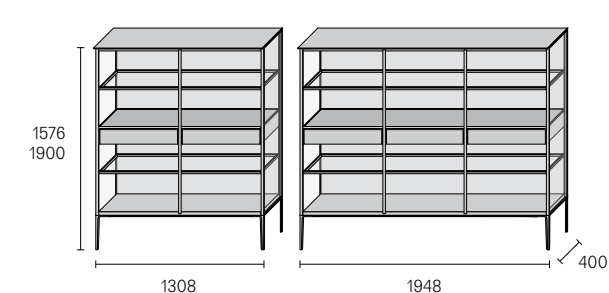

Madia espositore con top trasparente e ripiano interno  
Case sideboard with transparent top and internal shelf

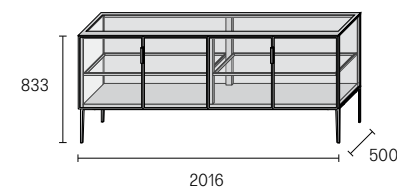

Madia espositore con top trasparente e cassetti interni  
Case sideboard with transparent top and internal drawers

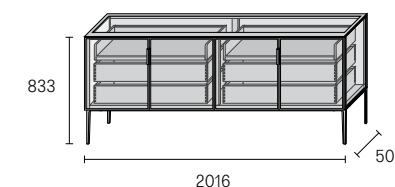

Isola: mobile espositore centro stanza con top trasparente  
Isola: middle room display unit with transparent top

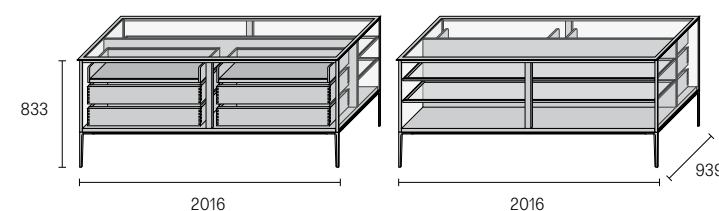

Vetrina pensile con anta battente  
Suspended cabinet with hinged door

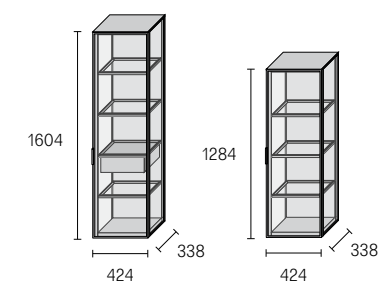

Vetrina pensile con anta  
Suspended cabinet with door

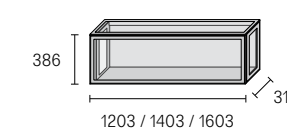



## Modularità Modular structure

Versione con basamento  
Version with floor base

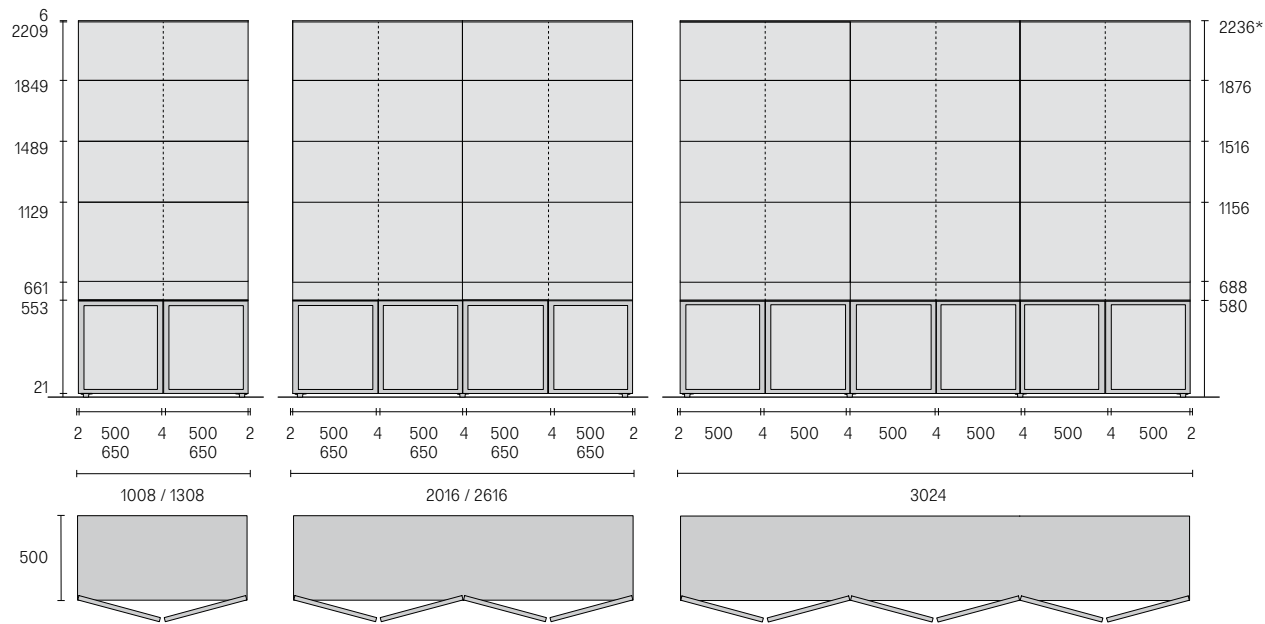

Versione con piedini  
Version with feet

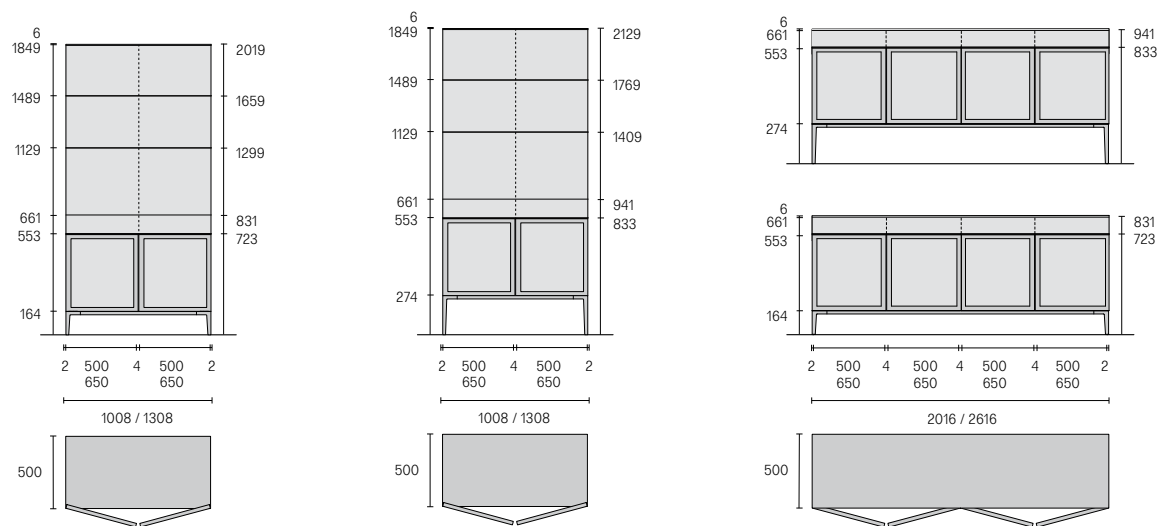

## Descrizione tecnica Technical description

Alambra è un sistema bifacciale in alluminio e vetro con top e basamento in legno disponibile in tre essenze: noce, rovere nero e rovere termotrattato. La struttura è disponibile in alluminio brown, nero e platino. Ante, spalle, schienali e ripiani sono realizzati in vetro temperato.

Alambra is a double sided system in aluminum and glass with wooden top and base, available in three finishes: walnut, black oak and heat treated oak. The structure is available in brown, black and platino aluminum. Doors, side panels, back panels and shelves are made of tempered glass.

Alambra ist ein freistehendes System aus Aluminium und Glas mit Holzabdeckplatte und Holzbasisboden erhältlich in 3 Ausführungen: Nussbaum, Eiche Schwarz und termobehandelte Eiche. Die Struktur ist verfügbar in Aluminium Brown, Aluminium Schwarz und Aluminium Platino. Türen, Seitenteile, Rückwänden und Böden sind in temperiertem Glas.

Alambra est un système biface en aluminium et verre avec top et base en bois disponible en noyer, chêne noir et chêne thermo-traité. La structure est disponible en aluminium brown, noir et platino. Portes, côtés, dos et étagères sont réalisées en verre trempé.

Alambra es un sistema bifacial en aluminio y cristal con el sobre y la base en madera disponible en tres acabados: nogal, roble negro y roble termotrattado. La estructura está disponible en aluminio brown, negro y platino. Las puertas, los laterales, la trasera y los estantes están realizados en cristal templado.

## Componenti Components

Spalla laterale in vetro temperato riflettente, trasparente, acidato e laccato opaco o lucido con struttura in alluminio. Side panel in reflective, transparent, etched and mat or glossy lacquered tempered glass with aluminum frame.

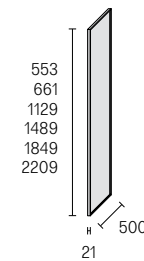

Schienale in vetro riflettente, trasparente, acidato, specchio e laccato opaco o lucido. / Back in reflective, transparent, etched, mirror and mat or glossy lacquered glass.

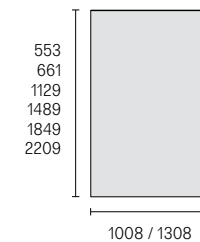

Montante centrale in estruso d'alluminio. Central upright in extruded aluminum.

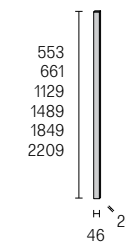

Anta in vetro temperato riflettente, trasparente, acidato e laccato opaco o lucido con struttura e laccato opaco o lucido con struttura e laccato opaco o lucido con struttura in alluminio, versione con e senza traversini Serratura opzionale. / Door in reflective, transparent, etched and mat or glossy lacquered tempered glass with aluminum frame, available with or without crosspieces. Optional locking.

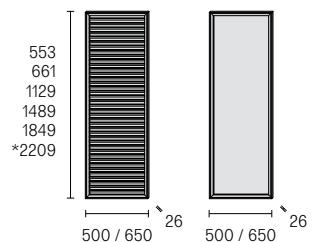

Top in legno e vetro temperato laccato opaco. Illuminazione led opzionale. Top in wood and tempered glass lacquered glass. Optional led lighting system.

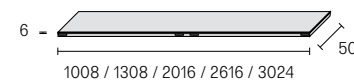

Top trasparente in vetro temperato con tiranti strutturali in alluminio. Illuminazione led anteriore e posteriore opzionali. Transparent top in tempered glass with structural aluminum bars. Optional front and rear led lighting.

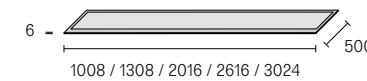

Cassetto sospeso in legno con lavorazione "a coda di rondine" e fondo rivestito in cuoio castoro. Telaio di supporto in acciaio laccato. / Wooden suspended drawer with dove-tie assembling and internal lining in castor leather. Supporting frame in lacquered steel.

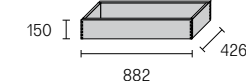

Cassettiere in legno in appoggio o sospese. / Floor or suspended wooden drawer units.

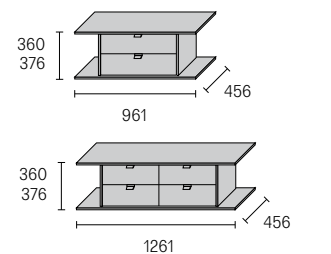

Ripiano interno in vetro temperato trasparente, acidato e laccato opaco o lucido, con ring in alluminio. Illuminazione a led opzionale. / Internal shelf in transparent, etched and mat or glossy lacquered tempered glass, with aluminum ring. Optional led lighting system.



Basamento in legno con puntali regolabili o con piedini in alluminio. Wooden base with adjustable tips or with aluminum legs.

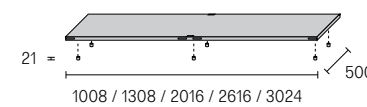

Mobile frigo bar in legno con ripiani rivestiti in cuoio castoro. Dotato di quattro vassoi porta oggetti rivestiti in cuoio castoro. Passacavi e prese elettriche opzionali. / Wooden fridge unit with shelves covered with castor leather. Equipped with four trays covered with castor leather. Optional cable duct and sockets.

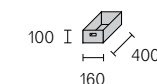
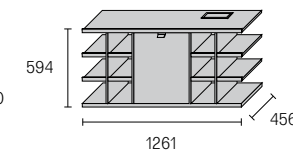

Cassetto sottotop in legno con fondo e divisori rivestiti in cuoio castoro, telaio perimetrale di supporto in alluminio. Wooden undertop drawer with bottom lining and dividers in castor leather, supporting surround frame in aluminum.

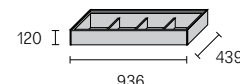
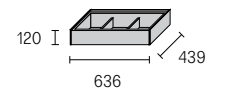

Illuminazione a led per top in legno o in vetro trasparente, ripiano in vetro e cassetto sospeso. / Led lighting system for wooden or transparent glass top, glass shelf and suspended drawer units.

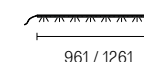

**Finiture  
Finishings**

Struttura  
Structure



Base, top, accessori interni  
Base, top, internal equipment

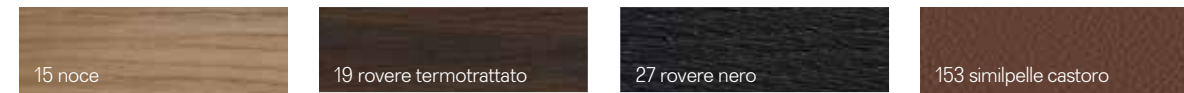

Cassetto sottotop, interno cassetto e accessori  
Undertop drawer, internal drawer, accessories

Top in vetro  
Glass top

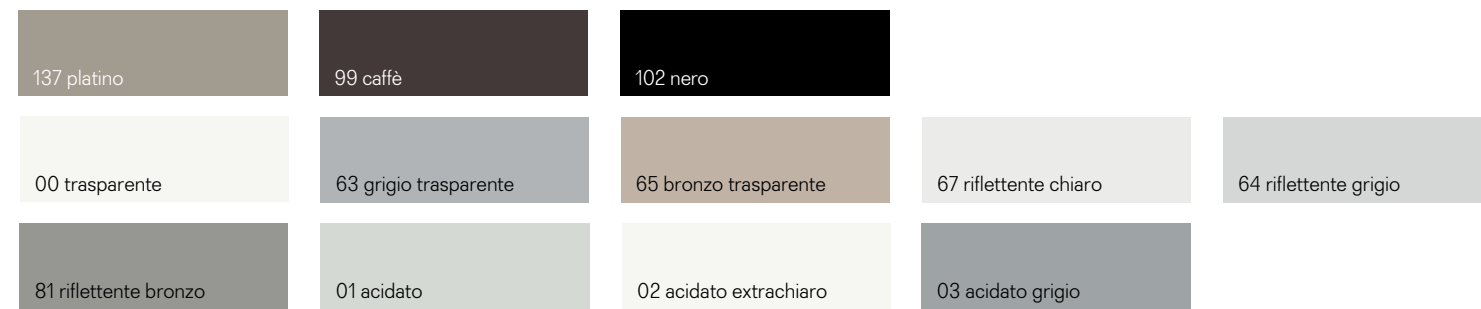

Vetri  
Glasses

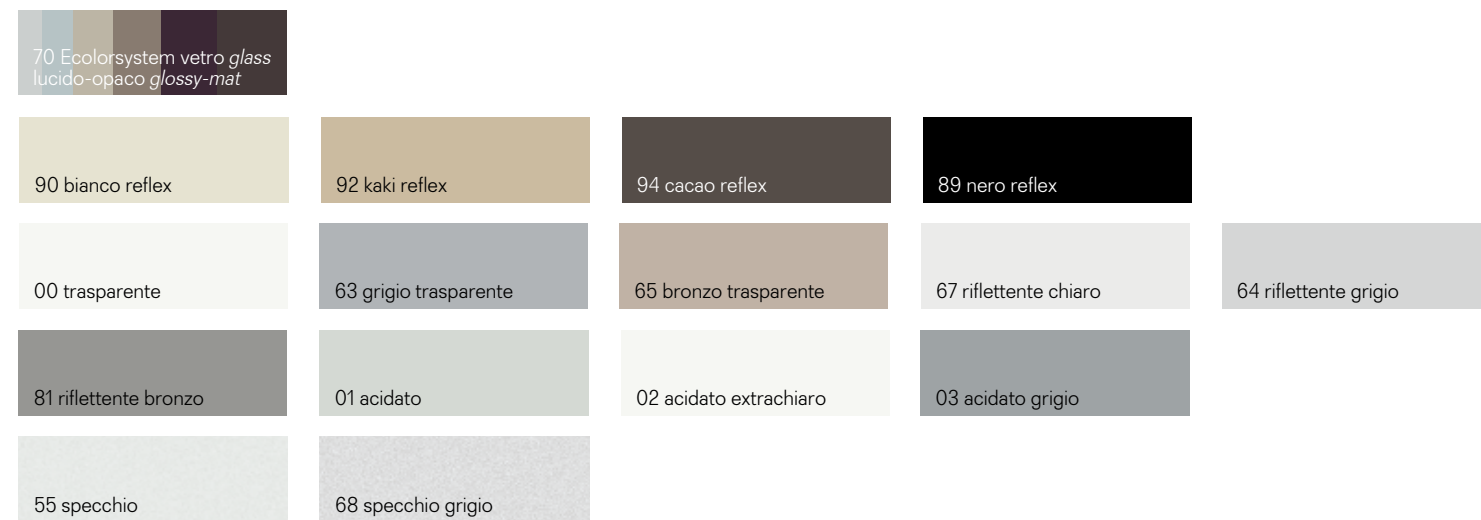

**Monetiere  
Monetiere**

Struttura  
Structure



Cassettiera interna, base e top  
Internal drawer unit, base and top

Top in vetro  
Glass top



Interno cassetto  
Internal drawer

Anta e fianco  
Hinged door and side

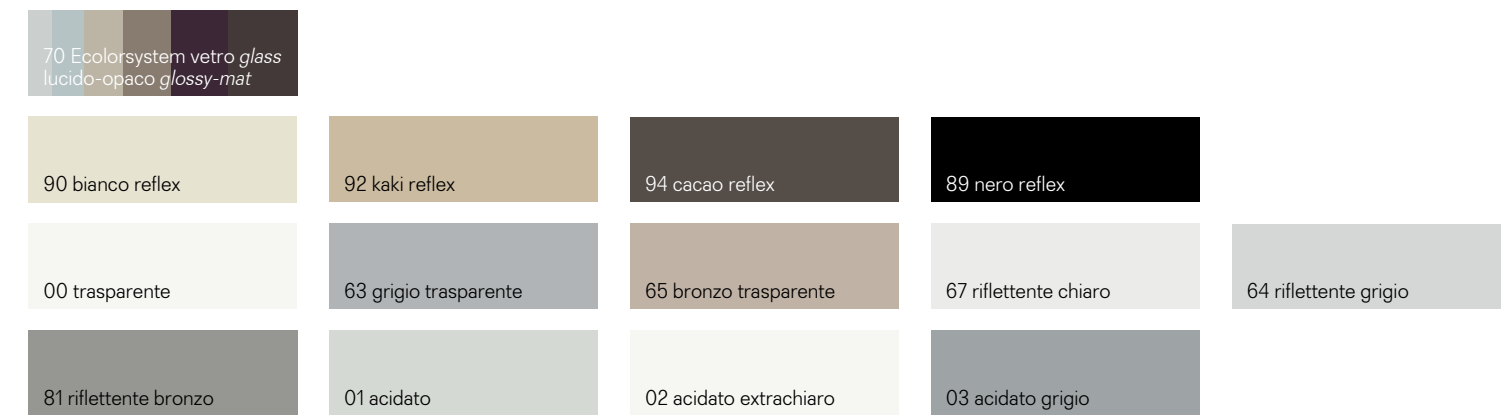

Schienale  
Back panel

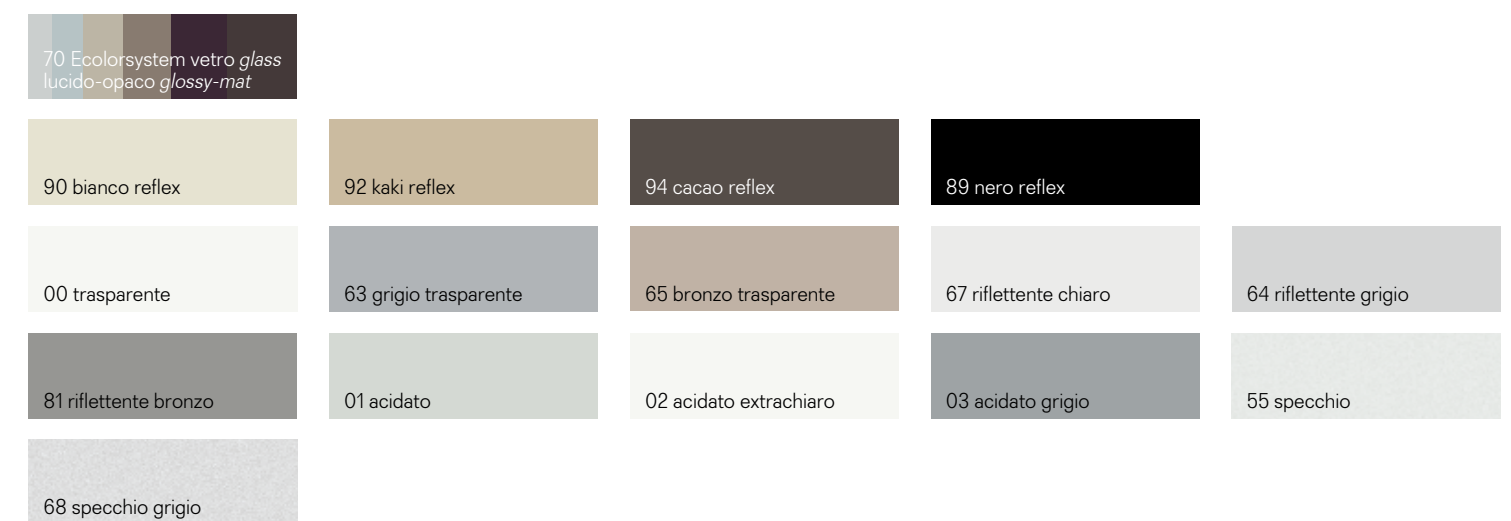

Libreria  
Bookcase

Struttura, base e top  
Structure, base and top

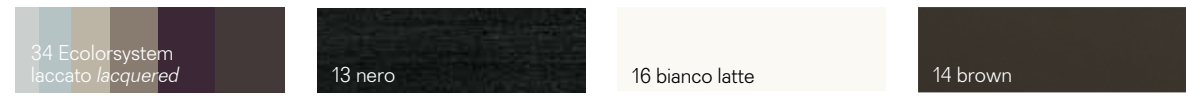

Fianco  
Side

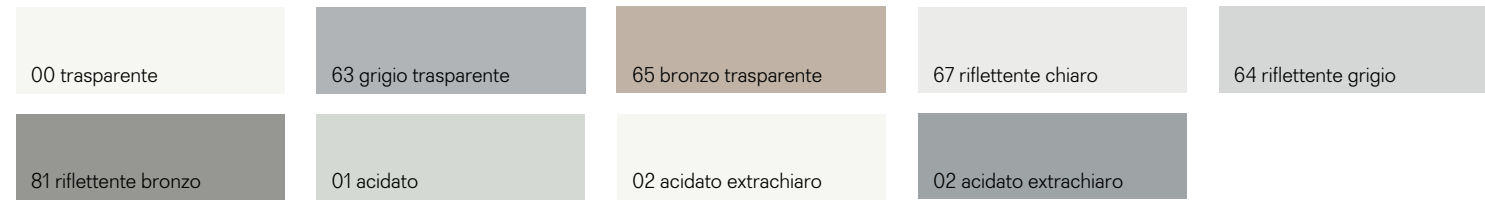

Schienale e cassetto  
Back panel and drawer

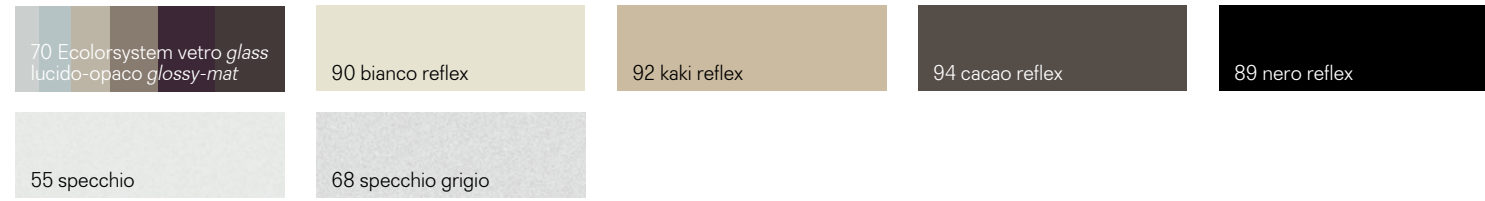

Ripiano  
Shelf



Isola e vetrina pensile  
Isola and suspended cabinet

Struttura, base e top  
Structure, base and top



Fianco e anta  
Side and door



Schienale  
Back panel

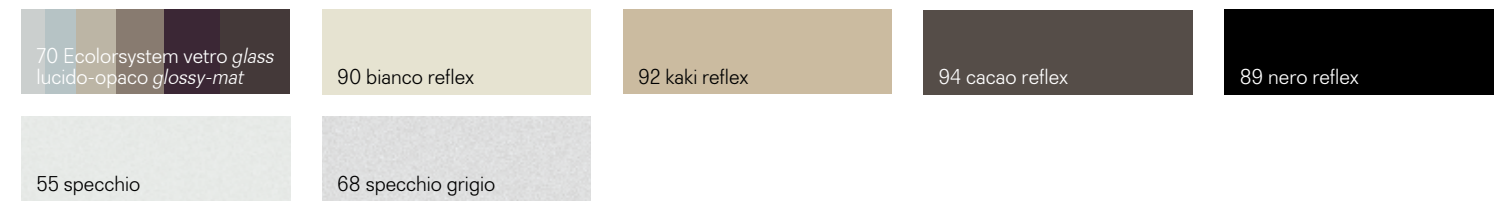

Ripiano  
Shelf

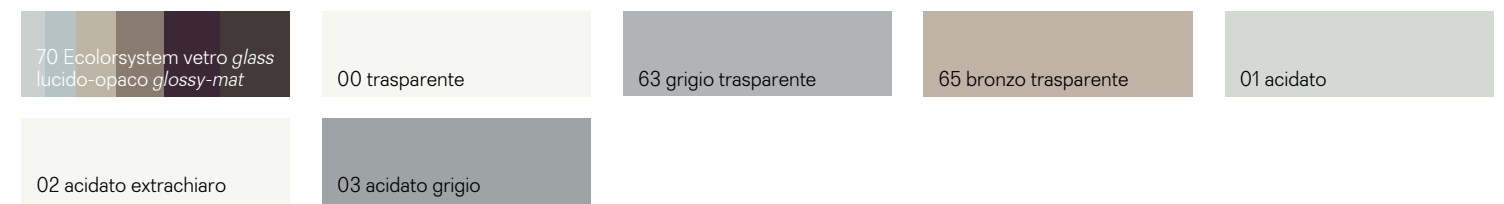

Cassetti  
Drawers



Interno cassetti  
Drawers internal lining







Design Giuseppe Bavuso

## Self

A modular system that allows to create single and double-sided sideboards, bedside tables, drawer units and suspended wall compositions. A versatile design, based on horizontal modularity, with drawers and hinged doors entirely covered in lacquered glass, and open compartments in walnut veneer or lacquered in Ecoloursystem colors.

Un sistema componibile che permette di creare medie mono e bifacciali, comodini, settimanali e composizioni sospese a parete. Un progetto versatile, basato su una modularità orizzontale, con elementi contenitori a cassetti e con anta battente, interamente rivestiti in vetro laccato, e da vani a giorno in essenza di noce o laccati nei colori Ecoloursystem.

Ein modulares System, mit dem man ein- und zweiseitige Schränke, Nachttische, Wochenzeitungen und Wandbehäng-Kompositionen erstellen kann. Ein vielseitiges Design, basierend auf horizontaler Modularität, mit Schubladeneinheiten und Drehtüren, das erhältlich ist aus komplett lackiertem Glas und offenen Fächern aus Nussbaumholz oder lackiert mit Ecoloursystem Farben.

Un système modulaire qui permet de créer des bahuts à une ou deux faces, des chevets, des semanaires et des compositions suspendues. Un design polyvalent, basé sur la modularité horizontale, avec des tiroirs et des portes battantes, entièrement recouvert de verre laqué, et des compartiments ouverts en noyer ou laqués dans les couleurs Ecoloursystem.

Un sistema modular que permite realizar aparadores mono o bifaciales, mesitas de noche, semanales y composiciones colgantes a pared. Un proyecto versátil, basado sobre una modularidad horizontal, con elementos contenedores con cajones y puertas abatibles, completamente cubiertos en cristal lacado, y módulos abiertos en madera de nogal o lacados en los colores Ecoloursystem.













Come tutte le proposte Rimadesio, il sistema Self è dotato di un'ampia varietà di soluzioni e dettagli tecnici che ne assicurano la più completa funzionalità, abbinata alla massima qualità estetica. I contenitori con apertura a ribalta, con ante interamente in alluminio, sono dotati di apertura push.

As per all Rimadesio proposals, the Self system is equipped with a wide variety of solutions and technical details, ensuring the most comprehensive functionality, combined with the highest aesthetic quality. Storage units with flap doors, whose aluminum doors are fitted with push opening.

Wie bei Rimadesio üblich, hat auch das System Self mehrere Anbaumöglichkeiten und technischen Details, die dessen kompletter Funktionalität und Ästhetik entsprechen. Container mit Vollaluminiumklapptür; Push-pull Öffnung.

Comme toutes les propositions Rimadesio, le système Self est doté de plusieurs solutions et détails techniques qui assurent une fonctionnalité totale liée à une esthétique maximale. Les meubles avec porte abattante entièrement en aluminium, sont dotés d'une ouverture à pression.

Como todas las propuestas Rimadesio, el sistema Self está dotado por una amplia variedad de soluciones y detalles técnicos que aseguran la más completa funcionalidad, junto con la más alta calidad estética. Los contenedores con puertas abatible por completo en aluminio, tienen apertura push.





Elementi a parete indipendenti in libero posizionamento, da comporre senza vincoli: questa è la concezione progettuale del sistema Self, che riflette uno dei trend più attuali per l'arredo della zona giorno. Self prosegue nella formulazione di soluzioni innovative che la collezione Rimadesio dedica all'area living contemporanea. Il profilo di aggancio a parete, che garantisce un'installazione senza viti a vista, contiene il sistema di illuminazione a led.

Free positioning and modular wall suspended units: this is the design concept of the Self system, which reflects one of the latest favourite trends for the living room styling, thus allowing innovative solutions for the contemporary living room. The wall-fixed profile guarantees an installation without visible screws, and includes the led lighting system.

Elemente die frei und grenzenlos positioniert werden können. Dies war das Ziel dieses Projektes Self, dass dem Trend des aktuellen Wohnstils folgt. Das modulare System Self verfolgt eine exklusive Gestaltung durch Rimadesio im Wohnbereich. Das Wandbefestigungsprofil, ohne sichtbare Schrauben, garantiert eine leichte Installation und kann die Led Beleuchtung integrieren.

Éléments muraux indépendants, à positionner librement, sans contraintes pour les compositions: il s'agit du concept propre du système Self qui reflète la dernière tendance, la plus actuelle, pour l'aménagement de la zone jour. Self poursuit la recherche constante de Rimadesio, pour des solutions innovantes, dédiées à la zone jour contemporaine. Le profil de fixation au mur, qui garantit une installation sans vis visibles, contient le système d'éclairage à led.

Elementos a pared independientes en posición libre, que se componen sin limitaciones: este es el diseño conceptual del sistema Self, que refleja una de las tendencias más actuales para la decoración de la zona de día. Self continúa en la formulación de soluciones innovadoras que la colección Rimadesio dedica a la área living contemporánea. El perfil de enganche a la pared, que garantiza una instalación sin tornillos visibles, contiene el sistema de iluminación por leds.





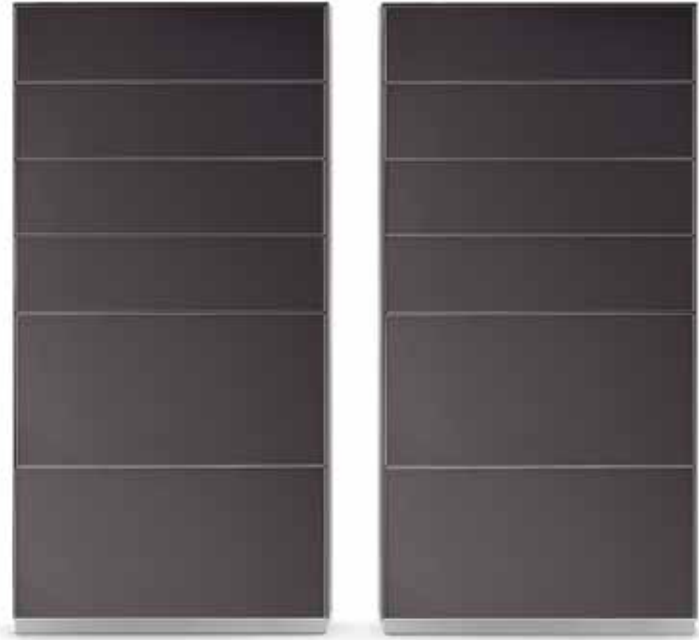

Contenitore settimanale *Drawer unit*  
 Struttura *Structure*: 30 alluminio  
 Vetro *Glass*: 129 amaranzo opaco  
 W 650 H 1319 D 470



Struttura *Structure*: 30 alluminio  
 Vetro *Glass*: 99 caffè opaco  
 W 1930 H 359 D 485



Design Giuseppe Bavuso

## Self bold

A simple and minimal design, perfect and pure lines, continuous surfaces: Self bold is the suspended modular system becoming a sideboard, expressing Rimadesio essential and contemporary design. Pure geometry and possibility to be combined with other collections, allow Self bold to be positioned with elegance and personality in every context. The top is one of the main characteristic of the collection, both when is more refined as thick marble, and in the glass version where a thin profile is marking the outline.

Un disegno pulito ed essenziale, linee assolute e nitide, superfici pure e continue: Self bold è il sistema d'arredo sospeso declinato anche nella configurazione a madia, che esprime l'essenzialità e la contemporaneità di Rimadesio. Geometrie assolute e capacità di dialogare con altre collezioni permettono a Self bold di inserirsi con eleganza e personalità nello spazio. Il top è uno dei tratti distintivi della collezione, sia quando si manifesta nella ricercata matericità dei marmi di forte spessore, sia quando nella versione in vetro viene definito da un sottile profilo che ne delinea l'ingombro.

Saubere und wesentliche Formen, klare und absolute Linien, reine und laufende Oberflächen: Self Bold als abgehangtes System oder Einzelmöbel entspricht der Wesentlichkeit und Modernität von Rimadesio. Dank der absoluten Geometrie und der Möglichkeit des Dialogs mit anderen Kollektionen von Rimadesio, kann sich Self Bold mit Eleganz und Personalität in den Raum integrieren. Charakteristisches Merkmal der Kollektion ist die Abdeckplatte, sowohl aus dickem Marmor als auch aus Glas mit feinerer Staercke.

Un design simple et pure, lignes absolues et nettes, surfaces harmonieuses et uniformes: Self bold est le système de meubles suspendus, et bahuts aussi, qui exprime la simplicité et modernité de Rimadesio. La géométrie absolue et la capacité de s'accoupler aux autres collections, permettent à Self bold de s'adapter avec élégance et personnalité à tous les espaces. Le top est un trait distinctif de la collection, aussi bien quand il est caractérisé par la matérialité recherchée des marbres épais, lorsque qu'il est défini, dans la version en verre, par son profil très fin qui en souligne la forme.

Un diseño limpio y esencial, líneas absolutas y nítidas, superficies puras y continuas: Self bold es el sistema de mobiliario colgante declinado también en configuración a aparador, que expresa la esencialidad y la contemporaneidad de Rimadesio. Geometrías absolutas y capacidad de dialogar con otras colecciones permiten a Self bold de encajar con elegancia y personalidad en el espacio. El top es uno de las señas de identidad de la colección, tanto cuando se manifiesta en la búsqueda de la materialidad del mármol de gran espesor, como cuando la versión del vidrio se define por un perfil fino que delinea la forma.

Struttura *Structure*: 300 rame  
 Fianchi e profilo posteriore *Sides and rear profile*: 200 rame spazzolato  
 Top in vetro *Glass top*: 133 rame opaco  
 Ante *Doors*: 81 riflettente bronzo  
 Interno vetrina *Internal cabinet*: 15 noce  
 Ripiani *Shelves*: 63 grigio trasparente  
 Schienale interno *Internal back panel*: 89 nero reflex



Un segno grafico, un profilo sottile che si fa volume, che definisce il perimetro di una forma, sottolinea una superficie, identifica uno spazio. Un gioco di piani ortogonali, di dettagli perfettamente coplanari, di materiali come il vetro, il marmo e il metallo che si relazionano attraverso spessori misurati che danno voce a un progetto rigoroso, equilibrato, coerente in tutti i suoi aspetti.

A graphic sign, a thin profile becoming a volume and defining the shape perimeter, highlighting the surface and identifying the space. A design based on different orthogonal planes, perfectly coplanar details, materials such as glass, marbles, metal that are combined through reduced thickness and create a rigorous, balanced and coherent project.

Ein grafisches Zeichen, ein feines Profil, welches sich Raum verschafft, das den Umfang einer Form definiert, unterstreicht eine Oberfläche und identifiziert einen Raum. Ein Spiel von rechtwinkligen Ebenen, von perfekten koplanaren Details, von Materialien wie Glas, Marmor und Metall, welche sich durch genaue Materialstärken miteinander kombinieren gibt einem rigorosem, und abgestimmten Projekt Ausdruck.

Un signe graphique, un profil mince qui rend le volume, qui définit le périmètre d'une forme, souligne une surface identifie un espace. Un jeu de plans orthogonaux, de détails parfaitement coplanaires, de matériaux tels que le verre, le marbre et le métal qui sont liés par des épaisseurs mesurées qui expriment une conception rigoureuse, équilibrée, cohérente dans tous ses aspects.

Un signo gráfico, un perfil fino que hace volumen, que define el perímetro de una forma, subraya una superficie, identifica un espacio. Un juego de planos ortogonales, los detalles perfectamente coplanares, de materiales tales como vidrio, el mármol y el metal que se relacionan a través de espesores medidos que dan voz a un diseño riguroso, equilibrado, coherente en todos sus aspectos.







Gli spessori importanti degli elementi orizzontali, il disegno essenziale delle ante che rivela la suddivisione dello spazio interno, l'assoluto equilibrio proporzionale. Self bold modifica la gerarchia formale della composizione con una scansione tripartita del volume di impostazione classica.

Thick horizontal elements, essential door design that reveals the internal partition, perfect proportional balance. Self bold changes the formal hierarchy of the composition by renovating the idea of volume.

Die auffällige Materialstärke der horizontalen Elemente, die wesentliche Zeichnung der Türen, welche die Unterteilung des Innenkorpusse andeuten, das absolut proportionale Gleichgewicht; Self Bold modifiziert die formale Hierarchie des Modells mit einer dreifachen Aenderung der klassischen Volumen.

Les épaisseurs des éléments horizontaux, la conception essentielle des portes qui révèle la subdivision de l'espace intérieur, un équilibre proportionnel absolu. Self bold modifie la hiérarchie formelle de la composition, renouvelant l'objet des volumes.

Los espesores importantes de los elementos horizontales, el diseño esencial de las puertas que revela la subdivisión del espacio interno, el equilibrio absoluto proporcional. Self bold modifica la jerarquía formal de la composición renovando el tema de los volúmenes.







Struttura *Structure*: 203 bronzo spazzolato  
 Vetro *Glass*: 84 moro lucido  
 Top in marmo *Marble top*: 180 emperador  
 W 2570 H 725 D 485

Struttura *Structure*: 69 palladio  
 Vetro *Glass*: 45 avorio lucido  
 Top in marmo *Marble top*: 28 calacatta  
 W 1290 H 1365 D 485

Struttura *Structure*: 200 rame spazzolato  
 Vetro *Glass*: 75 amaranto lucido  
 Top in vetro *Glass top*: 75 amaranto lucido  
 W 1930 H 725 D 485







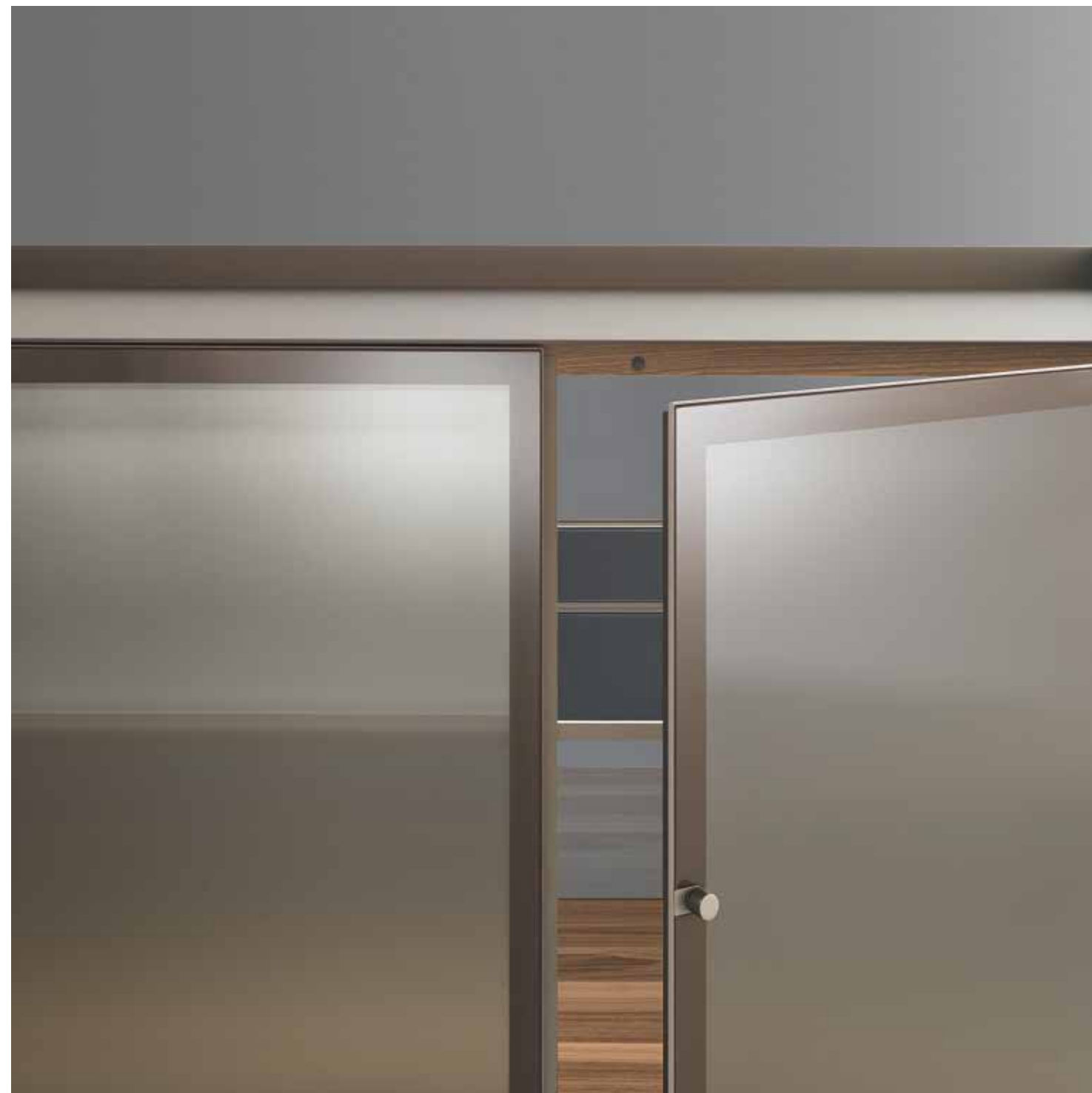

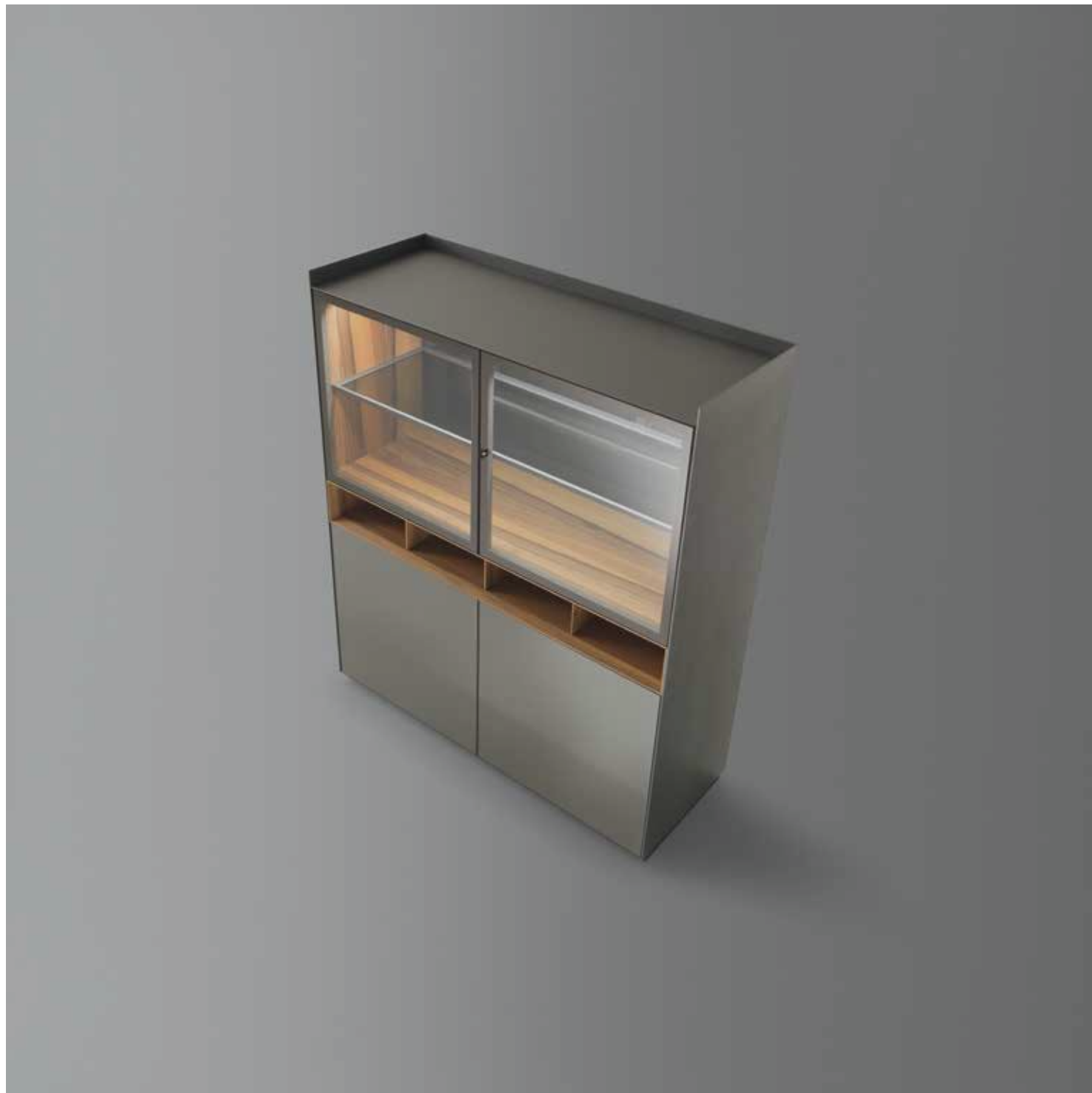

Struttura *Structure*: 83 piombo  
 Fianchi e profilo posteriore *Sides and rear profile*: 24 piombo spazzolato  
 Top in vetro *Glass top*: 127 piombo opaco  
 Ante in vetro *Glass doors*: 67 riflettente chiaro, 83 piombo lucido  
 Vani a giorno e interno *Open modules and internal cabinet*: 15 noce  
 Ripiano *Shelf*: 63 grigio trasparente  
 Schienale interno *Internal back panel*: 89 nero reflex  
 W 1290 H 1525 D 485

Self bold ➤



Comodino *Bedside unit*  
 Struttura *Structure*: 69 palladio  
 Vetro *Glass*: 45 avorio lucido  
 W 650 H 405 D 485

Settimanale *Drawer unit*  
 Struttura *Structure*: 203 bronzo spazzolato  
 Vetro *Glass*: 58 caffè lucido  
 Top in marmo *Marble top*: 180 emperador  
 W 650 H 1365 D 485

Comò *Dresser*  
 Struttura *Structure*: 201 peltro spazzolato  
 Pannelli in gres *Gres panels*: G002 moka  
 Top in gres *Gres top*: G002 moka  
 W 1930 H 725 D 485

Storage unit systems

Self bold ➤







Design Giuseppe Bavuso

## Self up

**Self Up:** the freestanding compositions characterized by the aluminium feet. A wide variety of solutions, defined by an aesthetics inspired to the maximum lightness. The feet, in the same colour of the profiles, are provided in the following finishings: aluminium, brown, black, bianco latte and lacquered in the 34 Ecoloursystem colours.

Self up: le composizioni freestanding caratterizzate dai piedini in alluminio. Un'ampia varietà di soluzioni compositive, definite da un'estetica ispirata alla massima leggerezza formale. I piedini, in tinta ai profili, sono previsti in finitura alluminio, brown, nero, bianco latte e laccata nei 34 colori Ecoloursystem.

Self up: die freistehenden Anlagen sind durch Aluminiumfüsse charakterisiert. Eine breite Vielfalt von Kombinationsmöglichkeiten ist durch eine formale Leichtigkeit gekennzeichnet. Die Füessen in der selben Farbe wie die Profile sind in Aluminum, Brown, nero, bianco latte und in den 34 Ecoloursystemfarben erhältlich.

Self up: les compositions autoportantes caractérisées par des pieds en aluminium. Une grande variété de compositions caractérisées par une esthétique inspirée par une légèreté formelle. Les pieds, dans la même finition des profils, sont disponibles en finition aluminium, brown, nero, bianco latte et laqués dans les 34 couleurs Ecoloursystem.

Self up: las composiciones freestanding se caracterizan por los pies en aluminio. Una amplia variedad de composiciones, caracterizadas por una estética inspirada a la máxima ligereza formal. Las patas, en tinta con los perfiles, son disponibles en acabado aluminio, brown, negro, bianco latte y lacadas en los 34 colores Ecoloursystem.

Struttura *Structure*: 300 rame  
Vetro *Glass*: 75 amaranato lucido  
W 1930 H 839 D 470



Un dettaglio che descrive le principali caratteristiche progettuali del sistema Self, con le superfici interamente in vetro laccato nei colori della collezione Ecolorsystem. Le possibilità dei contenitori prevedono cassetti di diverse altezze, ante a ribalta e ante battenti, tutte dotate di sistema di apertura push. La ricerca tecnologica Rimadesio ha permesso di progettare un'anta interamente in alluminio, caratterizzata dal profilo perimetrale continuo realizzato attraverso un'esclusiva tecnica di produzione.

A detail describing the main design features of Self system, with surfaces made entirely of lacquered glass in the Ecolorsystem colors. Storage units are available in several options: drawers in different heights, flap doors and hinged doors, all with push opening system. The Rimadesio technological research has designed a door made entirely of aluminum, characterized by entire perimeteral profile, achieved through a unique production technique.

Detail das die wichtigste Besonderheit von Self mit lackierten Glasoberflächen in den Ecolorsystem Farben darstellt. Die Anbaumöglichkeiten von Self bieten Schubladen in verschiedenen Höhen, Klapptüren, Drehtüren alle mit Push Pull Öffnung. Aufgrund der technischen Weiterentwicklung, hat Rimadesio, eine Tür komplett aus Aluminium entworfen. Charakterisiert wird diese durch ein umlaufendes Aluprofil, das aufgrund einer exklusiven Produktionstechnik, realisierbar geworden ist.

Un détail qui souligne les caractéristiques principales du projet du système Self, avec les surfaces entièrement en verre laqué dans les couleurs de la collection Ecolorsystem. Les possibilités des meubles prévoient des tiroirs de hauteurs différentes, des portes abatantes et battantes, dotées d'un système d'ouverture à pression. La recherche technologique de Rimadesio a permis de proposer une porte entièrement en aluminium, caractérisée par un profil périmétrique continu réalisé grâce à une technique exclusive de production.

Un detalle que describe las principales características de diseño del sistema Self, con las superficies completamente en cristal lacado en los colores de la colección Ecolorsystem. Las posibilidades compositivas prevén cajones de diferentes alturas, puertas abatibles y puertas batientes, todas con sistema de apertura push. La investigación tecnológica Rimadesio ha permitido diseñar una puerta hecha completamente en aluminio, caracterizada por el perfil perimetral continuo realizado a través de una técnica de producción única.







Struttura e vani giorno *Structure and open module*: 58 caffè  
Vetro *Glass*: 98 lino opaco  
W 2570 H 839 D 470

Self up ↗



Struttura *Structure*: 302 grafite  
Vetro *Glass*: 88 grigio scuro lucido  
W 2570 H 839 D 470

Storage unit systems

Self up ↗

Il sistema Self / Self up propone due versioni di interni, pensati per garantire una combinazione ideale con le finiture esterne della composizione. Dai toni chiari la prima, che prevede la struttura dei contenitori in melaminico cuoio grigio. Più recente la seconda versione dai toni scuri, che abbina la struttura in melaminico cuoio brown a qualsiasi colore dei profili. Tutti i componenti strutturali in alluminio, quali il profilo dell'anta e dei cassetti, lo zoccolino, il telaio per contenitori sospesi ed il basamento con piedini, sono disponibili in alluminio, nero, bianco latte, brown e nei 34 colori della gamma Ecolorsystem.

Self / Self Up system has two versions of internal finishing, conceived to guarantee the perfect combination with external composition finishings. The first proposal is based on light tones, providing the internal in grey leather melamine. The second and latest proposal is based on dark tones, combining the internal in brown leather melamine with all colours for the profiles. All structural components are in aluminum: the door and drawer profile, the skirting, the wall hanging brackets for suspended units and the supporting base with feet, are available in aluminum, black, bianco latte, brown and 34 Ecolorsystem colours.

Das System Self / Self Up bietet zwei Innenausführungen, um die ideale Kombination mit den Aussenausführungen der Anlage zu garantieren. Bei hellen Lacktönen außen, kommt die Innenstruktur aus Melaminleder grau zum Einsatz, zu dunkleren Farbtönen außen wird die Innenstruktur aus Melaminleder brown mit allen Farben der Profile kombiniert. Alle Strukturelemente aus Aluminium, wie Umrandungsprofile der Schubladen und der Türen, die Sockel, das Profil des Aufhängungssystems, und die Füße sind in verschiedenen Farben erhältlich wie Aluminium, nero, bianco latte, brown und in den 34 Ecolorsystemfarben der Kollektion.

Le système Self / Self-up est disponible avec deux finitions pour l'intérieur, conçues à assurer une combinaison idéale avec les finitions extérieures de la composition. Nuances claires pour la première, qui comprend la mélamine en cuir gris, plus récent la deuxième version avec des tons sombres, qui combine la mélamine en cuir brown avec tous les couleurs des profils. Tous les éléments en aluminium, tels que le profil des portes et tiroirs, le plinth, la structure de soutien pour les meubles suspendus et les piétements, sont disponibles en aluminium, nero, bianco latte, brown et dans les 34 couleurs de la gamme Ecolorsystem.

El sistema Self / Self up ofrece dos versiones de internos, diseñados para asegurar una combinación ideal con los acabados exteriores de la composición. De los tonos claros el primero, que proporciona la estructura de los contenedores en melamina cuero gris. Más recientemente la segunda versión con tonos oscuros, que combinan la estructura de melamina cuero brown a cualquier color de los perfiles. Todos los componentes estructurales en aluminio, tales como el perfil de la hoja y de los cajones, el zócalo, el marco para los contenedores colgantes y la base con patas, están disponibles en aluminio, negro, bianco latte, brown y en los 34 colores de la gama Ecolorsystem.



Struttura Structure: 14 brown  
Vetro Glass: 126 palladio opaco  
Vani a giorno Open modules: 15 noce  
Interni Internal cabinet: UB09 melaminico cuoio brown  
W 1290 H 1479 D 470

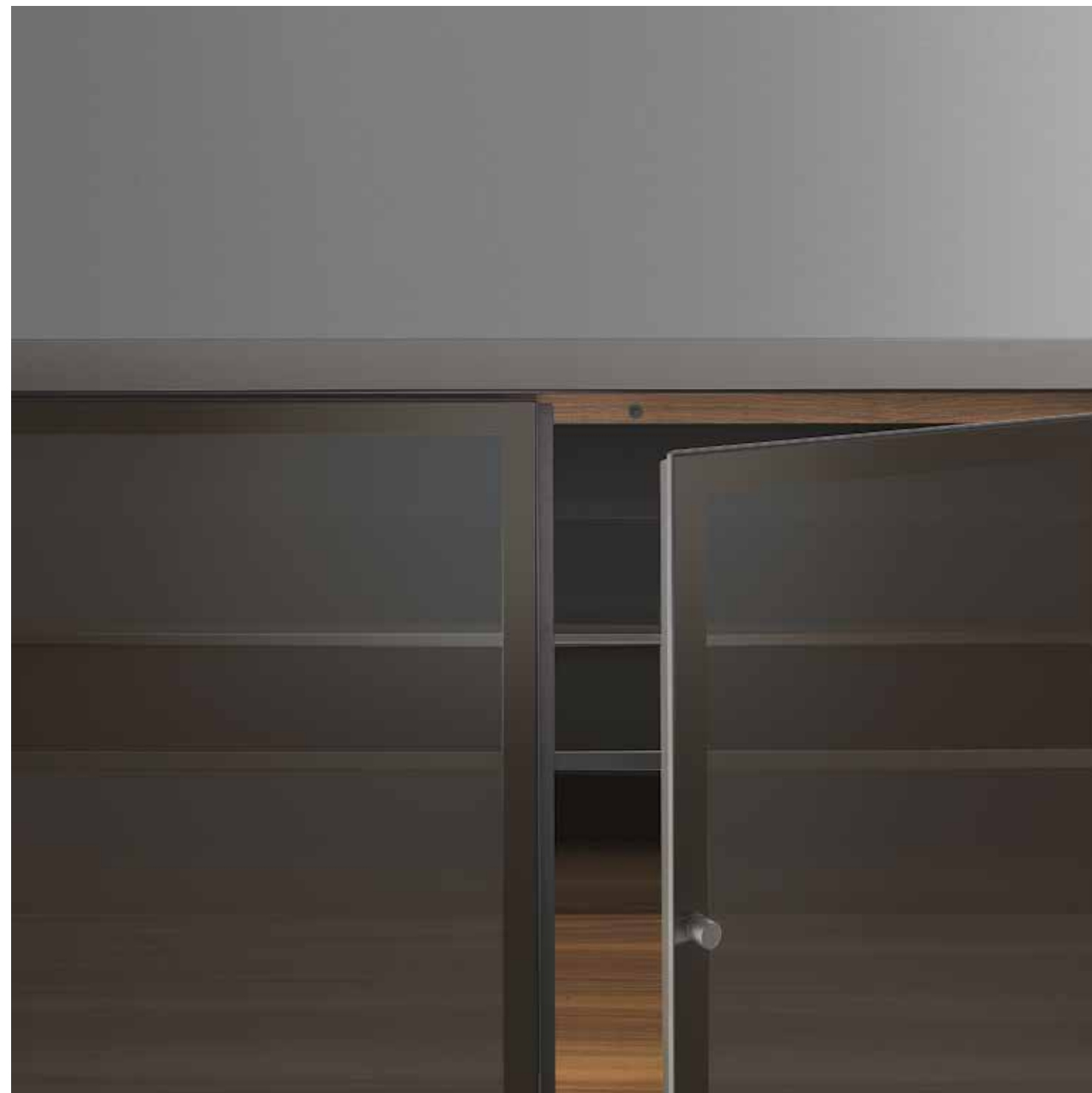

Struttura *Structure*: 84 moro  
Fianchi, top e schienale *Sides, top and back panel*: 84 moro lucido  
Interni e vani a giorno *Internal cabinet and open modules*: 15 noce  
Ante in vetro *Glass doors*: 81 riflettente bronzo  
Ripiani interni *Internal shelves*: 63 grigio trasparente  
Schienale interno *Internal back panel*: 89 nero reflex  
W 1290 H 1639 D 470



Versatilità, coerenza, perfezione assoluta nella modularità geometrica: il sistema Self up prevede la soluzione libreria confermando le sue particolarità distintive. Una versione tipologica che trova posto in diversi ambienti della casa nei quali svolge la propria funzione conferendo stile e uniformità all'insieme.

Versatility, coherence, perfection in geometrical modularity: Self up system can be displayed as bookcase with distinctive characteristics. This typology finds the right place in different domestic areas with the same functionality, thus giving style and coherence to the environment.

Vielseitigkeit, Konsistenz, absolute Perfektion der geometrischen Kombinierbarkeit. Eine typologische Version, die in den verschiedenen Räumen des Hauses einsetzbar ist, und die Stil und Einförmigkeit verleiht.

Polyvalence, cohérence, perfection absolue de la modularité géométrique: le système Self up dans la version bibliothèque, toujours avec ses particularités distinctives. Version typologique qui trouve place dans plusieurs espaces de la maison, dans lesquelles Self remplit sa fonction avec style et uniformité à l'ensemble.

Versatilidad, coherencia, perfección absoluta en la modularidad geométrica: El sistema Self up ofrece la solución librería confirmando sus peculiaridades distintivas. Versión tipológica que encuentra lugar en varios ambientes en las cuales cumple su función y estilo, dando uniformidad al conjunto.



Realizzati con l'esclusiva tecnologia di piegatura "folding", i vani a giorno del sistema Self sono interamente laccati nei 34 colori opachi del sistema Ecolorsystem. I ripiani interni e i divisori verticali, di soli 5 mm di spessore, sono realizzati in laminato plastico stratificato, un materiale che garantisce la massima solidità e resistenza. Per i vani a giorno appesi a parete, Rimadesio ha sviluppato un esclusivo sistema di aggancio che prevede tutte le possibilità di regolazione necessarie per assicurare una perfetta messa in bolla.

Realized with the unique folding technology, open modules are entirely lacquered in 34 mat colors of the Ecolorsystem range. Internal shelves and vertical dividers, only 5 mm thick, are made of laminated plastic, a material that provides maximum strength and durability. Rimadesio developed an exclusive fixing system for suspended open modules with the possibility to be perfectly adjustable.

Die in "Folding" Technik hergestellten offenen Faecher sind in den 34 matten Farben aus unserem Ecolorsystem lackierbar. Die 5 mm starken Innenboeden und die senkrechten Unterteilungen sind aus kunststoffbeschichtetem Laminat. Ein sehr hartes und belastbares Material. Fuer die aufgehengten offenen Faechern hat Rimadesio einen exklusiven Befestigungsbeschlag entwickelt. Dieser Beschlag erlaubt die notige Regulierung fuer eine waagerechte Installation.

Réalisés avec la technologie exclusive de pliage "folding" les meubles ouverts du système Self sont entièrement laqués dans les 34 couleurs mats du système Ecolorsystem. Les étagères à l'intérieur et les diviseurs verticaux de seulement 5 mm d'épaisseur, sont réalisés en stratifié, un matériau qui garantit solidité et résistance maximale. Pour les modules ouverts suspendus, Rimadesio a développé un exclusif système de fixation, qui comprend tous les équipements nécessaires pour assurer une parfaite régulation.

Realizados con la exclusiva tecnología de plegado "folding", los módulos abiertos del sistema Self son totalmente lacados en los 34 colores mates del sistema Ecolorsystem. Los estantes internos y los separadores verticales, de sólo 5 mm de grosor, son realizados en plástico laminado, un material que garantiza la máxima solidez y resistencia. Para los módulos colgantes a la pared, Rimadesio ha desarrollado un sistema de sujeción exclusivo, que ofrece todas las instalaciones de regulación necesarias para garantizar la nivelación perfecta.







Settimanale *Chest of drawers*  
 Struttura *Structure*: 30 alluminio  
 Vetro *Glass*: 98 lino opaco  
 W 650 H 1319 D 470

Secrétaire *Secrétaire*  
 Struttura *Structure*: 14 brown  
 Vetro *Glass*: 99 caffè opaco  
 W 650 H 1319 D 470

Comodino *Bedside unit*  
 Struttura *Structure*: 36 blu Londra  
 Vetro *Glass*: 117 blu Londra opaco  
 W 650 H 359 D 470



Struttura *Structure*: 14 brown  
 Vetro *Glass*: 99 caffè opaco  
 Cassettini con serratura *Drawers with key*: 19 rovere termotrattato  
 Piano scrittoio e cassetti interni  
 Writing desk and internal drawers: 153 similpelle castoro  
 Schienale *Back panel*: 68 specchio grigio  
 Illuminazione interna a led con sensore di accensione  
*Internal led lighting with sensor device*  
 W 650 H 1319 D 470





## Modularità Modular structure

Self - modularità P 470  
Self - modularity D 470

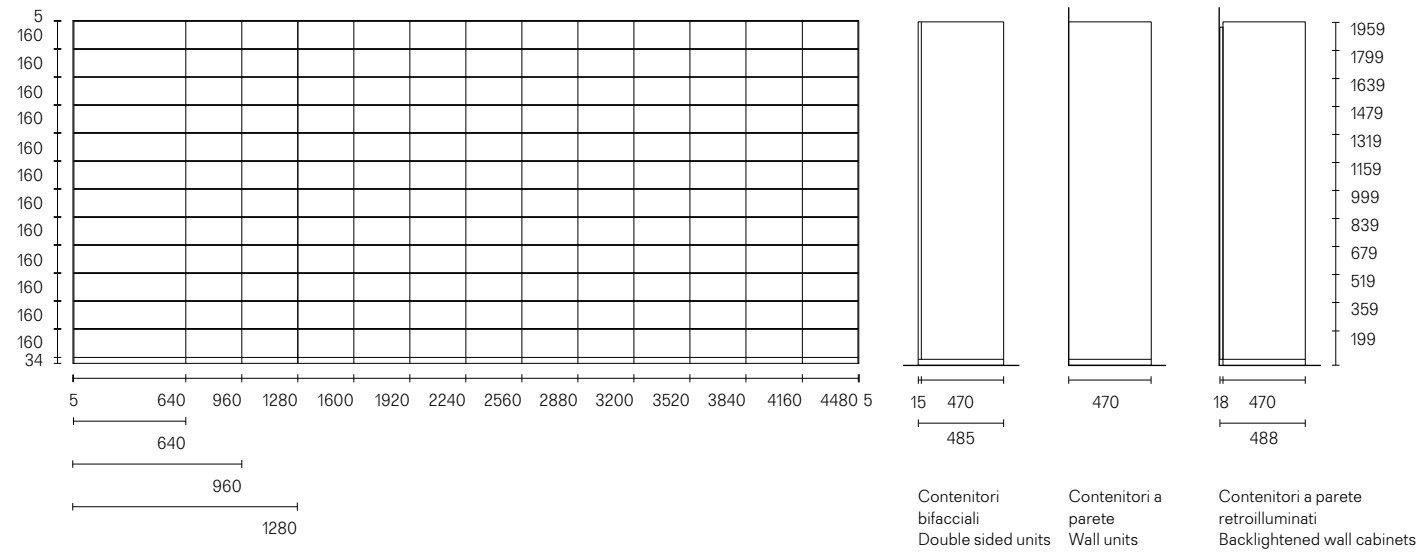

Contenitori bifacciali  
Double sided units

Contenitori a parete  
Wall units

Contenitori a parete retroilluminati  
Backlightened wall cabinets

Self - modularità P 335  
Self - modularity D 335

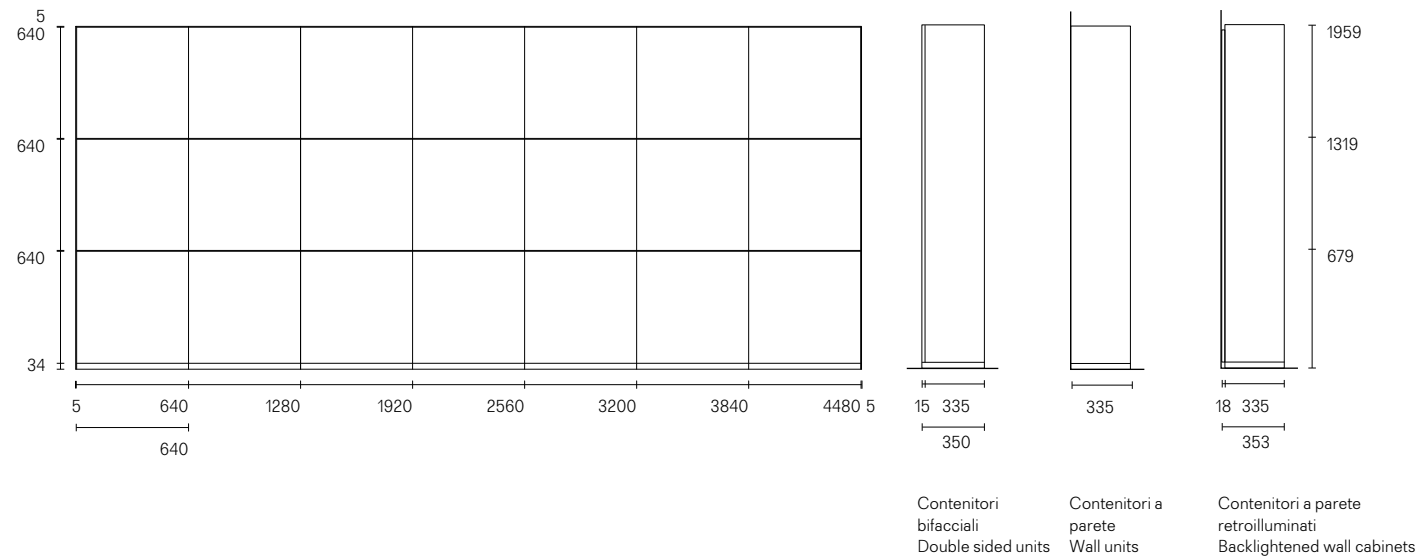

Contenitori bifacciali  
Double sided units

Contenitori a parete  
Wall units

Contenitori a parete retroilluminati  
Backlightened wall cabinets

## Descrizione tecnica Technical description

Il sistema Self è costituito da contenitori a cassetti, con anta battente o ribalta, interamente rivestiti in vetro laccato, e da vani a giorno in legno laccato nei colori ecolorsystem o in noce. I contenitori con larghezza 640, 960 e 1280 mm consentono di progettare nella massima libertà, grazie alla modularità a passo 320 mm. Le composizioni free-standing, disponibili in versione mono o bifacciale, sono dotate di zoccolo in alluminio oppure di piedini in pressofusione. Il profilo di aggancio a parete contiene il sistema di illuminazione a led e permette di creare composizioni sospese.

The Self system is composed by cabinets and drawers, with hinged or flap doors, entirely covered in lacquered glass, and by open modules lacquered in the Ecolorsystem colours or in walnut wood veneer. The cabinets with 640, 960 and 1280 mm width allow to project in complete freedom, thanks to the modularity multiple of 320 mm. The freestanding compositions, available in the mono or double-sided version, are equipped with an aluminium skirting or in die-casting aluminium feet. The wall hanging profile includes the led lighting system and allows to create suspended compositions.

Self System besteht aus Schubladenelementen, Klapp-türen oder Drehtüren aus lackiertem Glas, und geöffneten Modulen aus lackiertem Holz in Ecolorsystem Farbe oder nuß-baum. Module mit 640, 960 oder 1280 mm Breite ermöglichen eine freie Projektierung, danke zu der Modularität mit Abstand 320 mm. Freistehenden Kompositionen sind auch mit Sockel aus Aluminium oder Druckguss Fußgestell. Wand-befestigungsstruktur ist mit Led Beleuchtung ausgestattet und ermöglicht abgehängten Kompositionen zu realisieren.

Le système Self se compose de meubles tiroirs, avec porte battante ou abattante, entièrement recouverte de verre laqué, et de meubles ouverts en bois laqué dans les couleurs Ecolorsystem ou en noyer. Les meubles avec largeur 640, 960 et 1280 mm permettent de concevoir en totale liberté, grâce à une modularité chaque 320 mm. Les compositions free-standing, disponibles dans la version simple ou double face, sont équipées avec socle en aluminium ou piétement en pressé fusion d'aluminium. Le profil de support mural comprend le système d'éclairage à Led et permet de créer des compositions suspendues.

El sistema Self consta de contenedores con cajones, puerta batiente o abatible, totalmente cubiertos de cristal lacado, y de módulos abiertos en madera lacada en los colores Ecolorsystem o en nogal. Los contenedores con anchura de 640, 960 y 1280 mm permiten diseñar en la máxima libertad, gracias a la modularidad en el paso 320 mm. Las composiciones free-standing, disponibles en versión simple o bifacial, son dotadas de zócalo en aluminio o patas en inyección. El perfil de fijación a la pared contiene el sistema de iluminación por leds y permite la creación de composiciones colgantes.

Self up - modularità P 470  
Self up - modularity D 470

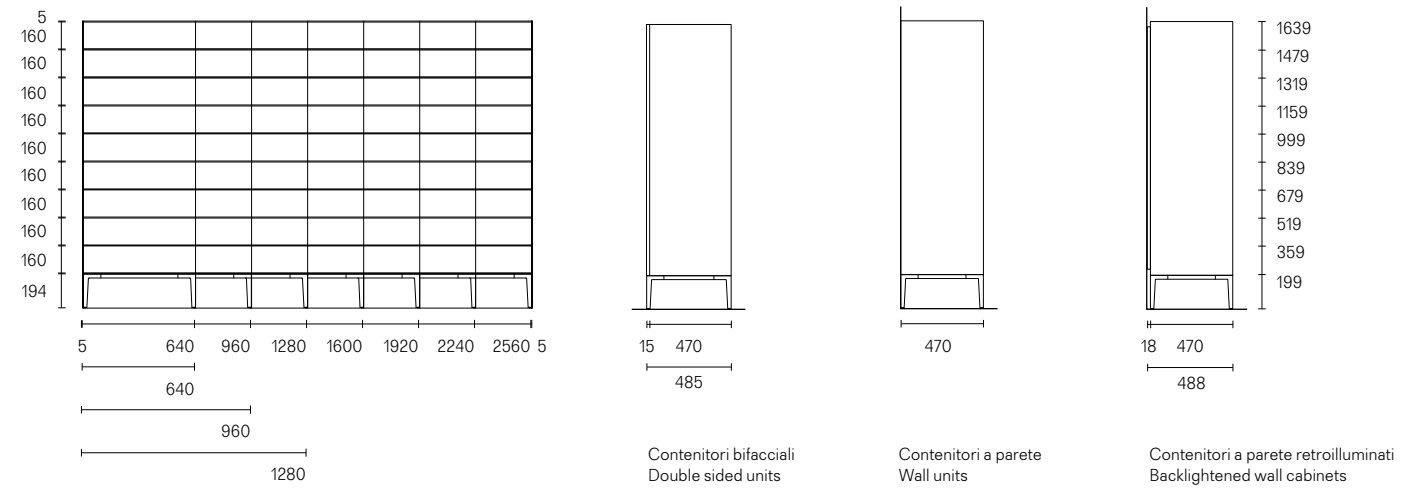

Contenitori bifacciali  
Double sided units

Contenitori a parete  
Wall units

Contenitori a parete retroilluminati  
Backlightened wall cabinets

Self up - modularità P 335  
Self up - modularity D 335

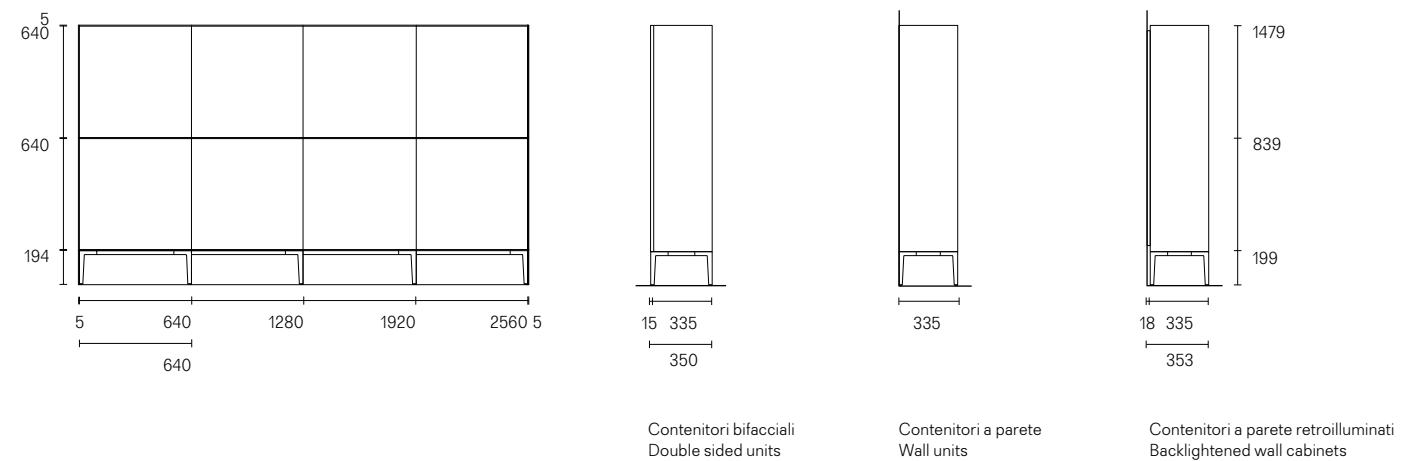

Contenitori bifacciali  
Double sided units

Contenitori a parete  
Wall units

Contenitori a parete retroilluminati  
Backlightened wall cabinets

Self bold - modularità P 470  
Self bold - modularity D 470

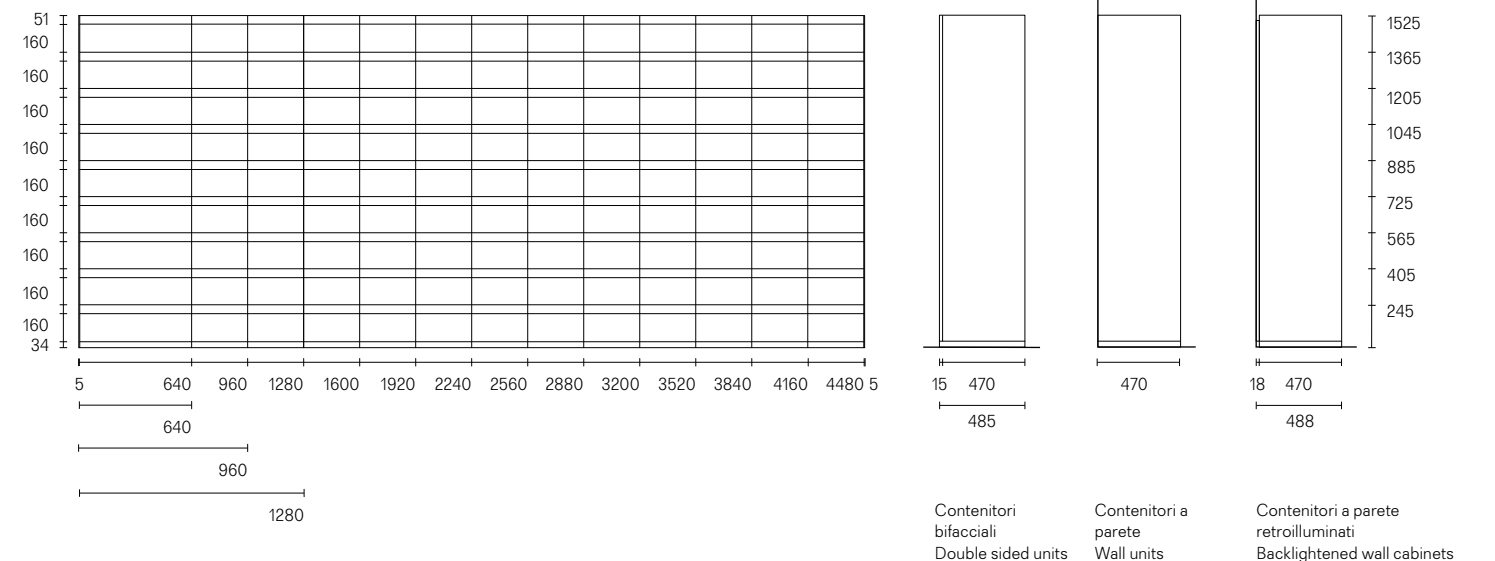

Contenitori bifacciali  
Double sided units

Contenitori a parete  
Wall units

Contenitori a parete retroilluminati  
Backlightened wall cabinets

**Componenti**  
**Components**

Top di finitura in vetro laccato per versioni a parete P 335/470 e freestanding P 350/485 / Finishing top in lacquered glass for wall versions D 335/470 and freestanding D 350/485

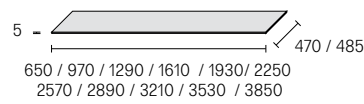
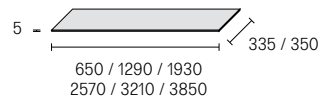

Zoccolo in alluminio  
Aluminum skirting

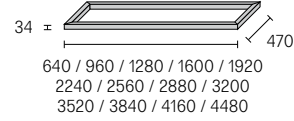
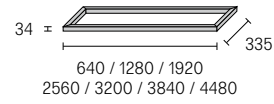

Basamento con piedini.  
Non disponibile per Self bold  
Base with feet.  
Not available for Self bold

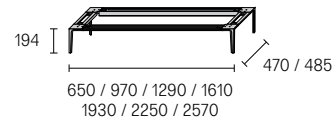
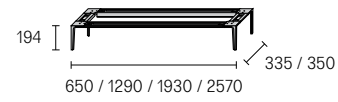

Fianco di finitura in vetro laccato per versioni a parete P 335/470 e freestanding P 350/485. Schienale di finitura opzionale per versioni freestanding verticali / Terminal panel in lacquered glass for wall versions D 335/470 and freestanding D 350/485. Optional back panel for vertical freestanding versions

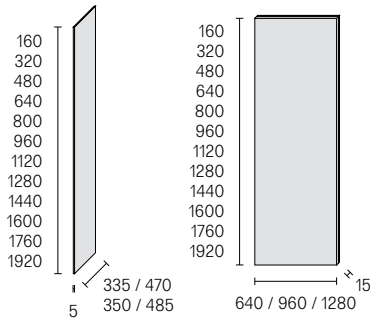

Schienale di finitura opzionale per versioni freestanding orizzontali  
Optional back panel for horizontal freestanding versions

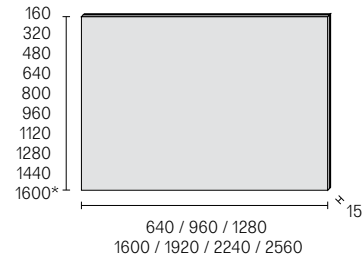

\*Non disponibile in gres. / Not available in gres.

Telaio per contenitori sospesi retroilluminati. Non disponibile per Self bold con top in marmo / Frame for backlit suspended cabinets with back lighting system. Not available for Self up and Self bold with marble top

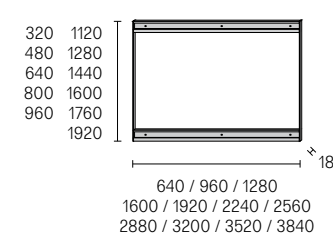

Illuminazione a led interna opzionale per vano con anta battente e anta a ribalta. Sensore di presenza integrato / Optional internal led lighting for hinged and flap door unit. Integrated presence sensor device

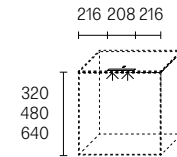

Passacavi opzionale, in vetro per il top e in alluminio per lo schienale  
Optional cable cut in glass for the top and in aluminum for the back panel

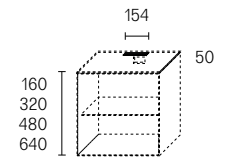

Contenitori con 1 e 2 cassetti push, guide ad estrazione parziale  
Cabinets with 1 and 2 push drawers, partially extractable runners

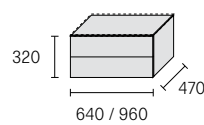
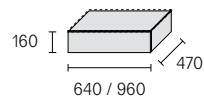

Contenitori con 1 e 2 cassettoni push, guide ad estrazione parziale  
Cabinet with 1 and 2 large push drawers, partially extractable runners

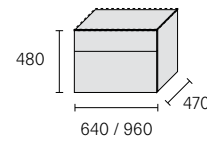
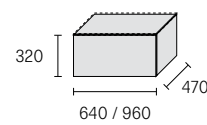

Contenitori con 1 e 2 cassetti e 1 cassettone push, guide ad estrazione parziale / Cabinet with 1 and 2 drawers and 1 push large drawer, partially extractable runners

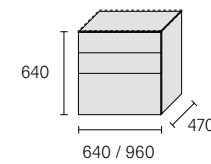
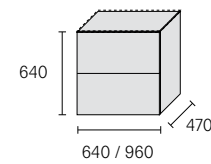

Contenitori con 3 e 4 cassetti push, guide ad estrazione parziale  
Cabinets with 3 and 4 push drawers, partially extractable runners

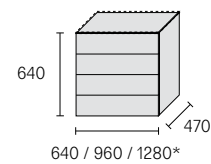
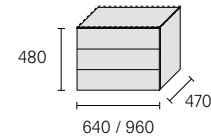

\*Disponibile solo per H 640. / Available only for H 640.

Fianco di finitura Self bold in alluminio  
Self bold aluminum finishing side

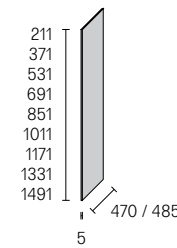

Profilo posteriore del top previsto per Self bold / Rear profile of the top available for Self bold

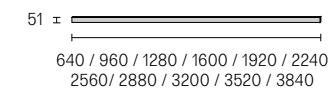

Top di finitura Self bold in gres spessore 5 mm / Self bold gres finishing top thickness 5 mm

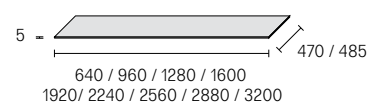

Top di finitura Self bold in marmo e in vetro spessore 51 mm / Self bold marble and glass finishing top thickness 51 mm

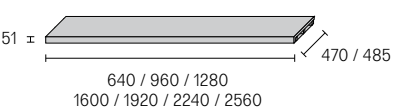

Contenitori con anta a ribalta  
Flap door cabinets

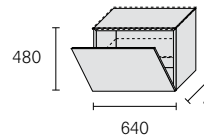
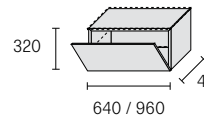
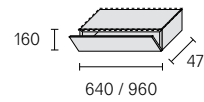

Contenitore vetrina in noce con ante battenti dotate di serratura  
Walnut cabinet with transparent glass hinged doors equipped with lock

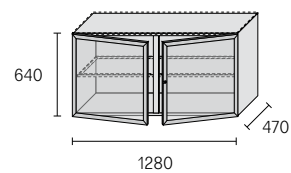

Contenitori con anta battente  
Wall fixed hinged door units

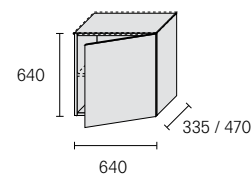
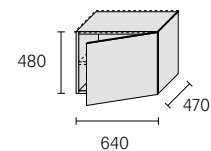

Contenitore con ante battenti  
Hinged door cabinet

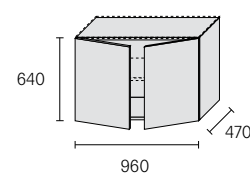
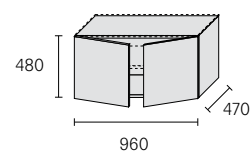

Vani a giorno laccati o in noce H 160  
Lacquered or walnut open modules H 160

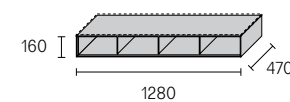
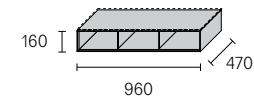
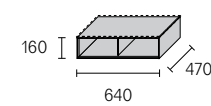

Vani a giorno laccati o in noce H 320 mm  
Lacquered or walnut open modules H 320 mm

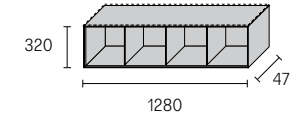
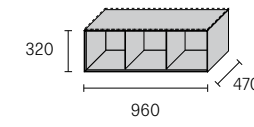
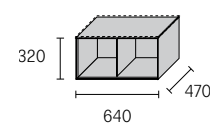

Vano a giorno laccato o in noce H 640 con schienali interni opzionali in specchio grigio / Lacquered or walnut open module H 640 with optional back panel in gray mirror

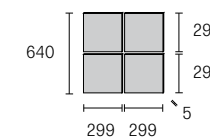
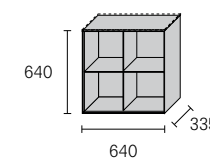

Vani tecnici a giorno laccati o in noce, ripiano laccato opzionale P 405 per vano H 320 / Technical lacquered or walnut open modules, optional lacquered shelf D 405 for module H 320

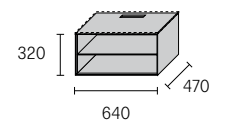
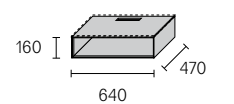



Tipologie estetiche  
Aesthetical typologies



1.



2.

1. Cassetto in alluminio con fondo in melaminico cuoio grigio, disponibile anche in versione a estrazione totale. Aluminum drawer with bottom in grey leather melamine, also available with fully extractable runners.
2. Cassetto in alluminio brown con fondo in melaminico cuoio brown, disponibile anche in versione a estrazione totale. / Brown aluminium drawer with bottom in brown leather melamine, also available with fully extractable runners



3.



4.

3. Contenitore con anta a ribalta in alluminio, interno in melaminico cuoio grigio, ripiano in vetro temperato in tinta alla scocca. Zoccolo in alluminio. Cabinet with aluminium flap door, internal finish grey leather melamine, shelf in lacquered glass in the same colour of the supporting structure. Aluminium skirting.
4. Contenitore con anta a ribalta in alluminio brown, interno in melaminico cuoio brown, ripiano in vetro temperato in tinta alla scocca. Zoccolo in alluminio brown. Cabinet with brown aluminium flap door, internal finish brown leather melamine, shelf in lacquered glass in the same colour of the supporting structure. Brown aluminium skirting.

Secretaire  
Secretaire



1.



2.

- Gli interni dei cassetti ed il piano scrittoio sono rivestiti in similpelle castoro (1) o argilla (2). Il secretaire ha il vano superiore con interni in noce (3) oppure in rovere termotrattato (4) e schienale in specchio grigio.  
The internal structure of the drawers and the writing desk are covered in castor (1) or argilla (2) synthetic leather, the secretaire has the upper compartment with internal structure in walnut (3) or heat-treated oak (4) and backrest in grey mirror.



3.



4.

Self

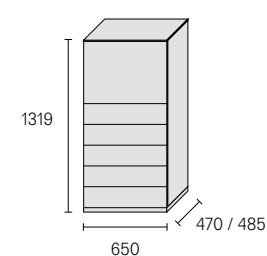

Self bold

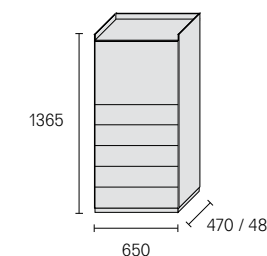

Self up

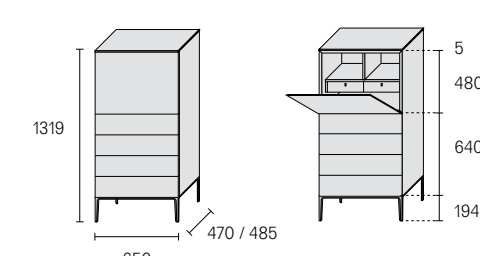

Descrizione tecnica  
Technical description

La collezione Self prevede la secretaire personalizzabile con tutti gli abbinamenti previsti per vetro e struttura e disponibile nelle tre varianti "Self", "Self up" e "Self bold". Il sistema prevede un'illuminazione interna a led con sensore di accensione a infrarossi e una alimentazione elettrica interna.

The Self collection includes the secretaire version, customizable with all the combinations for glass and structure, available in three versions: "Self", "Self up" and "Self bold". The system includes internal LED lighting system with infrared sensor device and internal power supply.

Die Self-Kollektion sieht die anpassbare Secretaire-Version mit allen Kombinationen für Glas und Struktur vor und ist in den drei Versionen "Self, Self up und Self bold" erhältlich. Das System bietet eine interne LED-Beleuchtung mit Infrarot-Sensor und eine interne Stromversorgung.

La collection Self prévoit la version secretaire personnalisable avec toutes les finitions prévues pour le verre et la structure et disponible dans les trois versions "Self, Self up et Self Bold". Le système est disponible avec un éclairage LED interne optional avec un capteur d'allumage infrarouge et une alimentation interne.

La colección Self prevé la versión Secretaire personalizable con todas las combinaciones previstas para cristal y estructura y disponible en las tres versiones "Self, Self up y Self bold". El sistema prevé una iluminación LED interna con sensor de encendido por infrarrojos y una alimentación eléctrica interna.

**Finiture**  
**Finishes**

**Self, Self up**

Basamento con zoccolino, piedini, profilo anta e cassetto  
Base with skirting, feet, drawer and hinged door profile



Top, fianco, schienale, anta e cassetto  
Top, side, back, hinged door and drawer fronts



Interno melaminico e ripiano interno in vetro laccato  
Internal melamine and lacquered glass internal shelf



Ripiano interno opzionale  
Optional internal shelf

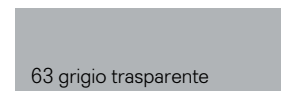

Sponde cassetto  
Drawer runners



Schienale interno opzionale  
Optional back panel

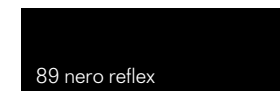

Vano a giorno  
Open module



Schienale opzionale per vano giorno / Optional back panel for open module

**Secretaire Self, Self Bold, Self up**  
**Self, Self Bold, Self up secretaire**

Sponde cassetto  
Drawer runners

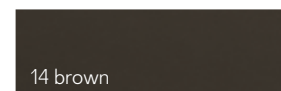

Interno cassetto  
Internal drawer



Piedini, cassetto e profilo anta  
Feet, drawer and hinged door profile



Interno secretaire  
Internal secretaire



Schienale interno  
Internal back panel



**Self bold**

Basamento con zoccolino, profilo anta e cassetto  
Base with skirting, drawer and hinged door profile



Schienale, anta e cassetto  
Back, hinged door and drawer fronts

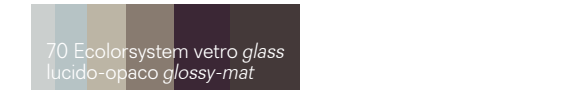

Telaio a parete per contenitore  
sospeso / Wall hanging  
brackets for suspended unit

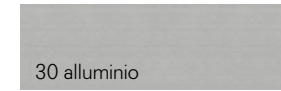

16 bianco latte

14 brown

G001 crema

G002 moka

13 nero

Fianco e profilo posteriore  
Side and back profile

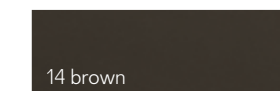
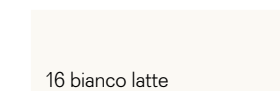

200 rame spazzolato

201 peltro spazzolato

14 piombo spazzolato

202 grafite spazzolato

203 bronzo spazzolato

Top  
Top

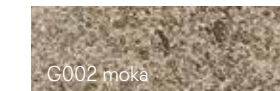
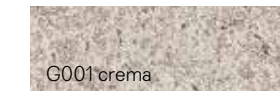
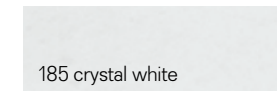
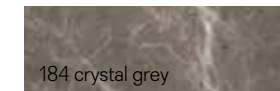
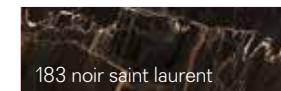
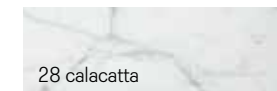

Sponde cassetto  
Drawer runners

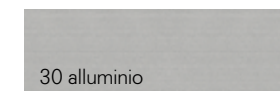

Interno melaminico e ripiano interno in vetro laccato  
Internal melamine and lacquered glass internal shelf



Vano a giorno  
Open module

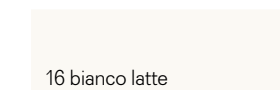





Design Giuseppe Bavuso

## Abacus living

Abacus living is a new conception of the living room system. The design consists of a back panel in lacquered glass, a pure surface with light and reflections, which holds storage units made entirely of glass including drawers and sliding doors, extremely thin shelves and display cases with flap and sliding doors.

Abacus living è una nuova concezione del sistema giorno. Il progetto si compone di una boiserie di vetro laccato, superficie pura che vive di luce e riflessi, su cui si innestano contenitori interamente in vetro con cassetti e con ante scorrevoli, mensole di sottilissimo spessore e vetrine con ante a ribalta. Gli schienali sono dotati di sistema di illuminazione a led nella parte superiore e inferiore. L'ampia scelta di contenitori e accessori dedicati all'area living e all'HiFi consente di formulare soluzioni in linea con le abitudini più contemporanee, caratterizzate dall'estetica del vetro.

Abacus living ist eine neue Konzeption des Wohnsystems. Es besteht aus einer Boiserie aus lackiertem Glas, eine reine Oberfläche, die von Licht und Reflexen lebt und in die sich Glas-schränke, hauchdünne Konsolen und Vitrinen mit Klapptüren einfügen. Die Rückwände sind mit einem Led-Beleuchtungssystem im oberen und unteren Teil ausgestattet. Die große Auswahl an Schrankelementen und Zubehör für den Wohnbereich und HiFi gestattet Lösungen, die mit dem zeitgenössischen Geschmack im Einklang stehen und von der Ästhetik des Glases charakterisiert sind.

Abacus living est une nouvelle conception du système jour. Le système se compose d'une boiserie en verre laqué, une surface pure qui vit de lumière et de reflets, sur laquelle se greffent des éléments de rangement entièrement en verre avec des tiroirs et des portes coulissantes, des étagères d'une épaisseur très fine et des vitrines avec des portes abatantes. Les panneaux de fond sont équipés d'un système d'éclairage à led dans la partie supérieure et inférieure. Le grand choix d'éléments de rangement et d'accessoires dédiés à la zone jour et à la HiFi, permet de formuler des solutions en ligne avec les habitudes les plus contemporaines, caractérisées par l'esthétique du verre.

Abacus living es una nueva concepción del sistema para la zona de día. El proyecto está formado por una "boiserie" de cristal lacado, superficie pura que vive de luz y reflejos, en la que se integran muebles contenedores todos de cristal con cajones y con puertas correderas, estantes de un espesor muy fino y vitrinas con puertas abatibles. Los paneles traseros están equipados con un sistema de iluminación de led en la parte superior y inferior. La amplia selección de contenedores y accesorios destinados al área living y al HiFi, permite formular soluciones que encajan a la perfección con los estilos contemporáneos, caracterizados por la estética del cristal.





Il concept progettuale che definisce le ante scorrevoli del sistema Abacus living si basa su un sistema di scorrimento che si integra perfettamente con i ripiani, completato da una serie di spalle laterali in vetro che si inseriscono fra un ripiano e l'altro, chiudendo il vano. L'anta scorrevole in vetro è prevista in versione trasparente, riflettente oppure laccata lucida o opaca.

The project concept, defining the sliding doors of the Abacus living system, is based on a sliding system integrated into the shelves, completed by a series of glass side panels fixed between the shelves, thus closing the unit. The sliding door is available in transparent, reflective, glossy or mat lacquered glass.

Das Entwurfskonzept, das die Schiebetüren des Abacus Living-Systems auszeichnet, basiert auf einem Gleitsystem, das perfekt mit den Fachböden harmonisiert und durch eine Reihe von Seitenwänden aus Glas ergänzt wird, die zwischen den Fachböden eingefügt sind und das Fach abschließen. Die Glasschiebetür ist gedacht in klarem- oder reflektierendem Glas, in glänzendem- oder lackiertem Glas.

Le concept du project qui définit les portes coulissantes du système Abacus living se base sur un mécanisme de glissement parfaitement intégré dans les étagères, complété par une série des panneaux latéraux en verre fixés entre les deux étagères, en créant un espace. La porte coulissante en verre est disponible en version transparente, réfléchissante ou laquée brillante ou mate.

El concept de proyecto que define las puertas correderas del sistema Abacus living se basa en un sistema de deslizamiento que se integra perfectamente con los estantes, completado por una serie de paneles laterales en cristal que se intercalan entre un estante y otro, cerrando el compartimento. La puerta corredera en cristal se proporciona en cristal transparente, reflectante o lacado brillante o mate.















Proposte compositive  
Compositional proposals

Composizioni sospese  
Suspended compositions



Struttura *Structure*: 59 grigio chiaro  
Vetro *Glass*: 59 grigio chiaro lucido  
Vetrina con anta a ribalta *Glass cabinet with flap door*: 63 trasparente grigio  
Pannelli con illuminazione superiore e inferiore a led  
*Panels with upper and lower led lighting*  
Ripiani con illuminazioni a led *Shelves with led lighting*

Struttura *Structure*: 69 palladio  
Vetro *Glass*: 69 palladio lucido  
Pannelli con illuminazione superiore e inferiore a led  
*Panels with upper and lower led lighting*  
Ripiani con illuminazioni a led *Shelves with led lighting*

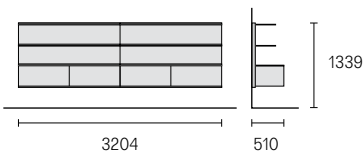
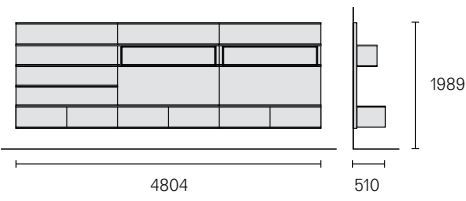

Composizioni con cassetti sospesi  
Compositions with suspended drawers



Struttura *Structure*: 58 caffè  
Vetro *Glass*: 99 caffè opaco  
Pannelli con illuminazione superiore a led *Panels with upper led lighting*  
Ripiani con illuminazioni a led *Shelves with led lighting*

Struttura *Structure*: 41 grigio ombra  
Vetro *Glass*: 104 grigio ombra opaco  
Contenitori sospesi *Suspended units*: 15 noce  
Pannelli con illuminazione superiore a led *Panels with upper led lighting*  
Ripiani con illuminazioni a led *Shelves with led lighting*

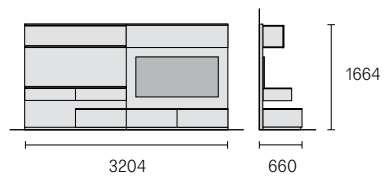
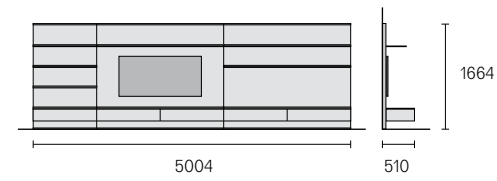



Proposte compositive  
Compositional proposals

Composizioni con contenitori sospesi in gres  
Compositions with gres suspended units



Struttura *Structure*: 304 platino  
Vetro *Glass*: 137 platino opaco  
Ante scorrevoli *Sliding doors*: 63 grigio trasparente  
Contenitori sospesi in gres *Gres suspended cabinets*: G001 crema  
Pannelli con illuminazione superiore a led *Panels with upper led lighting*  
Ripiani con illuminazioni a led *Shelves with led lighting*

Struttura *Structure*: 58 caffè  
Vetro *Glass*: 58 caffè lucido  
Contenitori sospesi in gres *Gres suspended cabinets*: G002 moka  
Pannelli con illuminazione superiore a led *Panels with upper led lighting*  
Ripiani con illuminazioni a led *Shelves with led lighting*

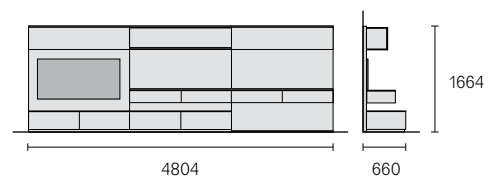
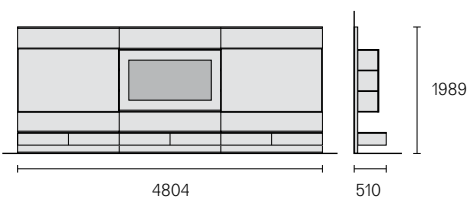

Dettaglio contenitori sospesi in gres P 450  
Gres suspended cabinets detail D 450



Struttura *Structure*: 58 caffè  
Vetro *Glass*: 58 caffè lucido  
Contenitori sospesi *Suspended cabinets*: G002 gres moka

## I dettagli del progetto Design details



1.

L'attenzione dedicata da Rimadesio alla zona giorno contemporanea trova conferma nella continua evoluzione del sistema giorno Abacus living, che si arricchisce di nuove soluzioni per +i contenitori e di dettagli funzionali evoluti.

Rimadesio dedicates particular attention to the contemporary living area, and it shows through the continuous evolution of the Abacus living system, enriched with new solutions for cabinets and with advanced functional details.



2.

Die Aufmerksamkeit, die Rimadesio dem modernen Wohnbereich widmet, spiegelt sich in der ständigen Weiterentwicklung des Systems für den Wohnbereich Abacus Living wieder. Abacus bereichert sich mit neuen Lösungen für die Elementen und fortgeschrittenen Details.

Rimadesio a consacré une attention toute particulière à la zone de jour contemporaine pour proposer une évolution continue du système jour Abacus living qui s'enrichit de nouvelles solutions pour les rangements et de nouveaux détails fonctionnels modernes.

1. Base doppia H 331 con anta ribalta e ripiano interno in alluminio / Double base H 331 with flap door and aluminum internal shelf
2. Base singola H 238 con anta ribalta / Single base H 238 with flap door

La atención que Rimadesio dedica a la zona de día contemporánea queda confirmada gracias a la continua evolución del sistema de día Abacus living, que se enriquece de nuevas soluciones para los contenedores y de avanzados detalles funcionales.



5.

Una nuova sfumatura di luce, più calda (3200° K), illumina le composizioni Abacus living. Faretto integrato nei ripiani e illuminazione diffusa superiore ed inferiore dei pannelli a parete.

A new shade of warmer light (3200° K) for the Abacus living compositions, from spotlights to soft lighting from the upper and lower back panel.



6.

Ein neuartiger, warmer Lichtton (3200° K) dient zur Beleuchtung der Abacus Living-Kombinationen, mit Leuchten, die zur gedämpfte Beleuchtung der Wandplatten von oben und unten in die Einlegeböden integriert sind.

Les compositions Abacus living sont éclairées par une nouvelle nuance de lumière, plus chaude (3200° K), émise par les spots à éclairage diffus placés dans les parties supérieure et inférieure des panneaux muraux.

5. Ripiano laccato e stratificato con faretto led incassato nello spessore del ripiano. Lacquered and laminated shelf with LED spotlight embedded into the shelf.
6. Ripiano in vetro temperato. I pannelli sono dotati di illuminazione led integrato sul led superiore. / Shelf in tempered glass. The panels are equipped with integrated LED lighting on the top.
7. Vetrina sospesa con anta a ribalta in vetro. Suspended display cabinet with glass flap door.

Una nueva tonalidad de luz, más cálida (3200° K), ilumina las composiciones Abacus living, de los focos integrados en los estantes a la iluminación difusa superior e inferior de los paneles de pared.



3.

Progettata per garantire il miglior risultato estetico, la canalina è dotata di prese elettriche e antenna tv e consente di collegare lo schermo a lettori e decoder, senza cavi a vista. Il top di finitura è dotato di profilo antipolvere.

Designed to guarantee the best aesthetic result, the cable-case is equipped with electrical sockets and tv aerials and allows the screen and decoder to be connected without visible cables. The finishing top comes with an anti-dust profile.



4.

Der verdeckte und damit höchsten ästhetischen Ansprüchen genügende Kabelkanal ist mit Steckdosen sowie einer Tv-Antenne ausgestattet und ermöglicht so den Anschluss von Bildschirmen und Decodern ohne sichtbare Kabel. Die Auflagefläche ist mit einem Staubschutzprofil ausgestattet.

Conçue pour garantir le meilleur résultat esthétique, la goulotte est dotée de prises électriques et antenne tv et permet de relier l'écran aux lecteurs et décodeur, sans cables apparents. Le dessus de finition est doté d'un profil anti-poussière.

3. Base profondità 600 mm con top di finitura dotato di profilo passacavi integrato. / Base unit depth 600 mm with top equipped with integrated cable duct.
4. Base profondità 600 mm con canalina elettrificata sottotop a scomparsa. / Base unit depth 600 mm with electrified and concealed cable duct under the top.

Diseñada para garantizar el mejor resultado estético, el canal para cables está dotado de tomas eléctricas y antena tv y permite conectar la pantalla a lectores y decoder, sin cables a la vista. El tablero de acabado está dotado de perfil antipolvo.



7.

La tecnologia Rimadesio ha permesso di rendere invisibile il meccanismo di apertura a gas e le cerniere, in pressofusione, che assicurano movimenti di apertura e chiusura ammortizzati e silenziosi. Dotata di maniglia incassata a scomparsa e di illuminazione interna a led, la vetrina ha il profilo perimetrale in alluminio laccato e lo schienale in tinta in vetro laccato lucido e temperato.

Rimadesio's technology allowed the gas opening mechanism and the die-casting hinges to become invisible and allow silent opening and closing movements. The display cabinet is equipped with an integrated hidden handle and with internal led lighting, the cabinet has an edging profile in lacquered aluminum and its back is in a matching colour in tempered glossy lacquered glass.

Die Rimadesio-Technologie hat es ermöglicht, den Öffnungsmechanismus mit Gas sowie die Druckguss-Scharniere, die gedämpfte und geräuscharme Öffnungs- und Schließbewegungen zulassen, unsichtbar zu machen. Ausgestattet mit blickdicht eingepasstem Griff und interner Led-Beleuchtung, verfügt die Vitrine über ein Umlaufprofil aus lackiertem Aluminium sowie eine farbige Rückseite aus glanzlackiertem, gehärtetem Glas.

La technologie Rimadesio a permis de rendre invisible le mécanisme d'ouverture à gaz et les charnières, en moulage sous pression, qui assurent les mouvements d'ouverture et fermeture amorties et silencieux. Dotée de poignée encastrée escamotable et d'éclairage interne à led, la vitrine est équipée avec un profil périmétral en aluminium laqué et le panneau de fond en verre trempé laqué brillant.

La tecnología Rimadesio ha permitido que el mecanismo de apertura neumática y las bisagras, en inyección sean invisibles, asegurando movimientos de apertura y cierre amortiguados y silenciosos. Dotada de tirador empotrado oculto y de iluminación interna de led, la vitrina tiene el perfil perimétrico de aluminio lacado y el panel trasero de color en cristal templado lacado brillo.

## Modularità Modular structure

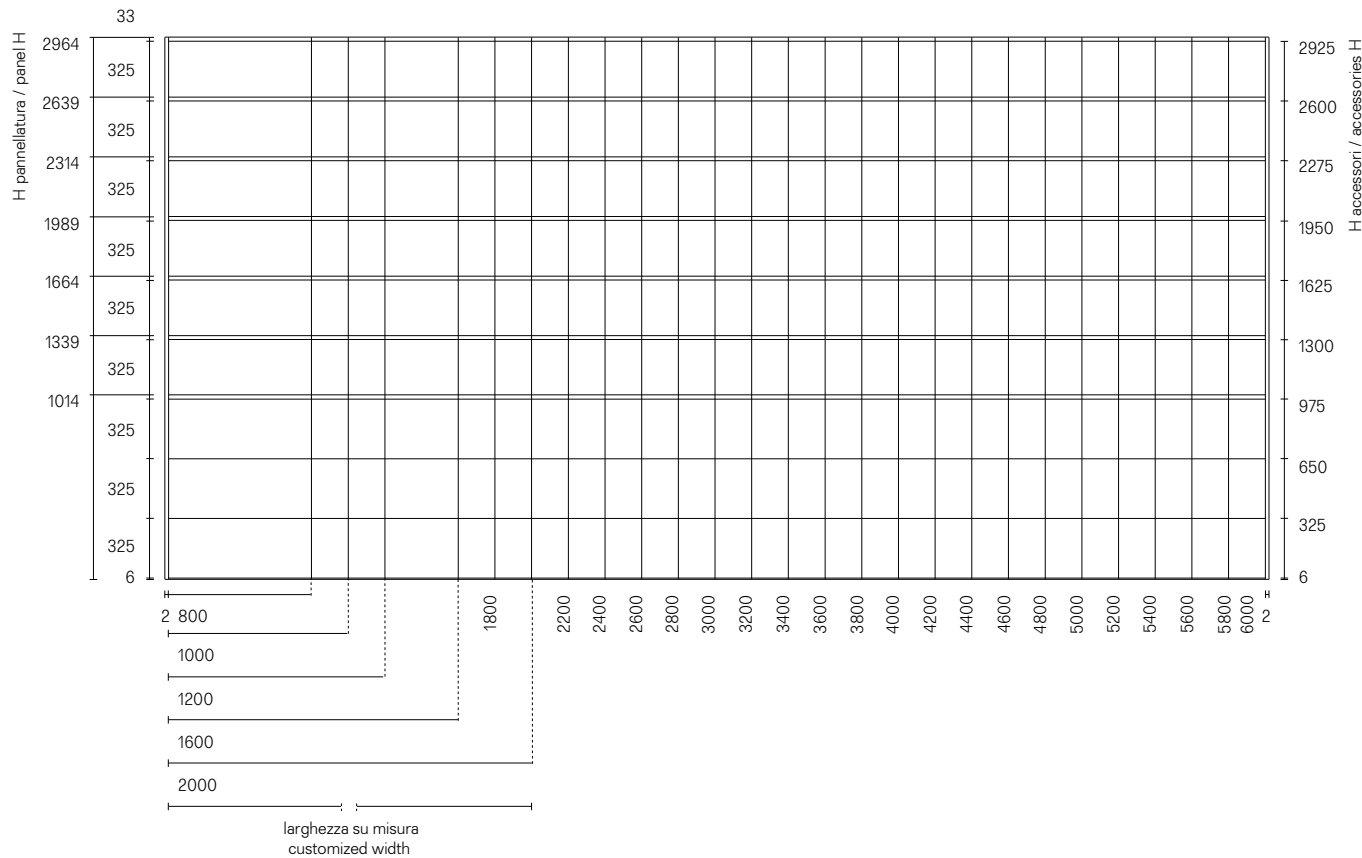

## Descrizione tecnica Technical description

La modularità del sistema Abacus living si basa su pannelli a parete in vetro laccato disponibili in 5 larghezze e 7 altezze. Il pannello, il ripiano e la panca a terra sono disponibili in 5 larghezze, con la possibilità di riduzione a misura. Tutti gli accessori sono disponibili in 70 tinte laccate ecolorsystem.

The modularity of the Abacus living system is based on wall fixed panels in lacquered glass available in 5 widths and 7 heights. The panel, the shelf and the floor bench are available in 5 different widths, with the possibility to reduce them on size. All the accessories are available in 70 tonalities of the Ecolorsystem colours.

Die Modularität des Abacus living Systems basiert auf lackierten Glaswandplatten, die in 5 Breiten und 7 Höhen erhältlich sind. Die Platte, der Fachboden und die Bodenbank sind in 5 Breiten erhältlich, mit der Möglichkeit, sie zu nach Maß zu reduzieren. Alle Zubehörteile sind in 70 Ecolorsystem lackierten Tönen erhältlich.

La modularité du système Abacus living est basée sur des panneaux au mur en verre laqué disponibles en 5 largeurs et 7 hauteurs. Le panneau, l'étagère et la base au sol sont disponibles en 5 largeurs, avec la possibilité de réduction sur mesure. Tous les accessoires sont disponibles en 70 couleurs laquées ecolorsystem.

El sistema modular Abacus living se basa en paneles a pared en cristal lacado disponibles en 5 anchuras y 7 alturas. El panel, el estante y la base son disponibles en 5 anchuras, con la posibilidad de reducirlos a medida. Todos los elementos accesorios son disponibles en 70 tintas lacadas ecolorsystem.

## Componenti Components

Pannello in vetro laccato e temperato, struttura in estruso di alluminio anodizzato. Profilo laterale in alluminio laccato. Illuminazione superiore e inferiore a led. Panel in lacquered and tempered glass, structure in extruded anodized aluminium. Lacquered aluminium side profile, upper and lower led lighting

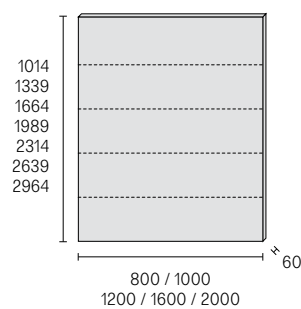

Pannello con struttura a scomparsa per tv lcd/led con 1 foro inferiore 260 x 86 mm o con 1 passacavi in vetro 260 x 86 mm / Panel with hidden frame for lcd/led tv with 1 lower hole, 260 x 86 mm or 1 glass cable-passage, 260 x 86 mm

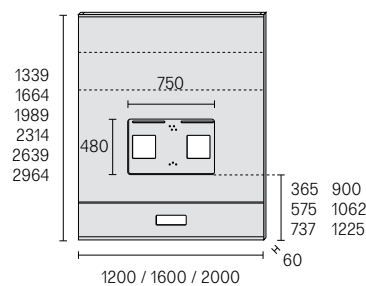

Staffa a parete per composizioni con pannelli sospesi / Wall fixing brackets for compositions with suspended panels

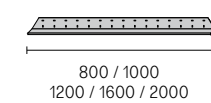

Illuminazione superiore e inferiore a led  
Upper and lower led lighting



Braccio estensibile porta tv lcd/led in color antracite / Extensible support for lcd/led tv in dark grey colour

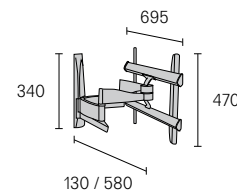

## Componenti Components

Ripiano laccato e stratificato in MDF rivestito da una doppia lastra di alluminio. Illuminazione a led opzionale. Laminated lacquered shelf in MDF, covered by a double aluminium sheet. Optional led lighting

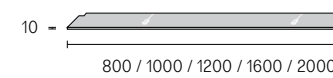

Ripiano in vetro temperato  
Shelf in tempered glass

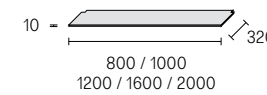

Top di finitura unico in vetro laccato, per basi e contenitori sospesi / Single top in lacquered glass, for floor bases and suspended cabinets

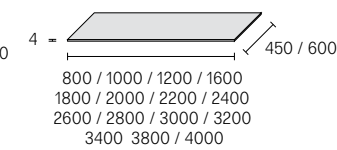

Anta scorrevole completa di binario di scorrimento e spalle in vetro trasparente o trasparente grigio / Sliding door equipped with sliding carriage and side panels in transparent or transparent grey glass

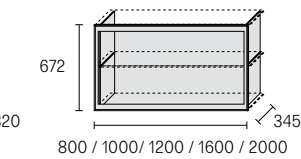
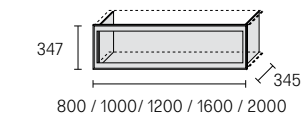

Top di finitura unico in legno o in gres, per basi e contenitori sospesi / Single top in wood, or porcelain, for floor bases and suspended cabinets

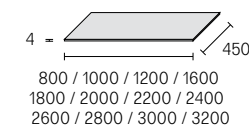

Anta scorrevole completa di binario di scorrimento e spalle in vetro trasparente o trasparente grigio / Sliding door equipped with sliding carriage and side panels in transparent or transparent grey glass

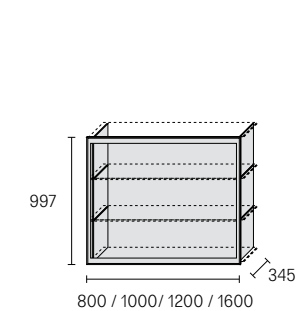

Panca a terra in vetro laccato temperato, zoccolo in alluminio e piedini regolabili / Floor bench in tempered lacquered glass with aluminium structure and adjustable feet

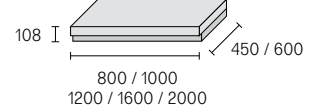

Anta scorrevole completa di binario di scorrimento e spalle in vetro trasparente o trasparente grigio / Sliding door equipped with sliding carriage and side panels in transparent or transparent grey glass

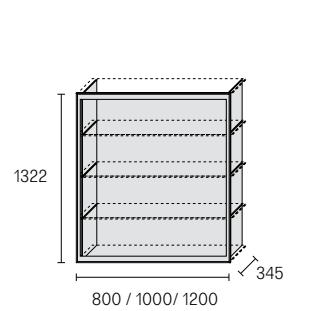

Base doppia in vetro laccato temperato con cassetto push, P 600 / Double base unit in tempered lacquered glass with push drawer, D 600

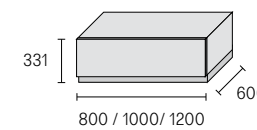

Base doppia in vetro laccato temperato con anta a ribalta, P 600 / Double base unit in tempered lacquered glass with flap door, D 600

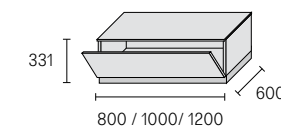

Base singola e doppia in vetro laccato temperato, gres o legno con cassetto push o con anta a ribalta. P 450 con pannello in vetro, P 458 a parete, P 453 bifacciale Single and double base unit in tempered lacquered glass, porcelain or in wood, with push drawer or with flap door. D 450 with glass panel, D 458 wall suspended unit, D 453 double sided

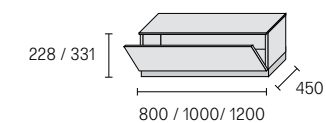
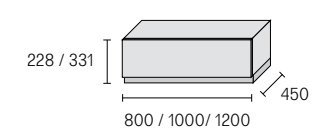

Contenitore singolo e doppio sospeso in vetro laccato temperato, gres o in legno con cassetto push in alluminio con guide ad estrazione totale o anta a ribalta. P 450 con pannello in vetro, P 458 a parete Single and double wall suspended unit in tempered glass, porcelain or in wood, with push drawer or with flap door. D 450 with glass panel, D 458 wall suspended unit

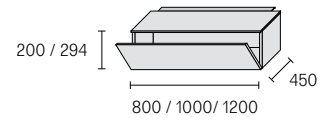
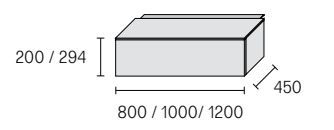



**Finiture**  
**Finishings**

Struttura, profilo laterale, mensola stratificata, anta, vetrina, accessori  
Structure, side profile, laminated shelf, hinged door, showcase, accessories

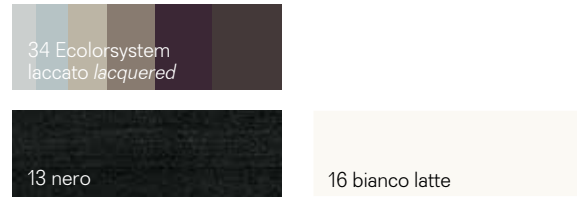

Zoccolino e profilo cassetto  
Skirting and drawer profile

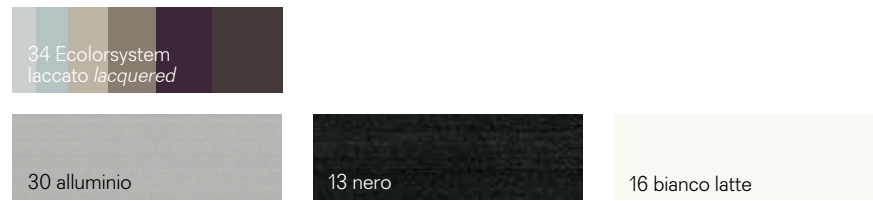

Pannello, base P 600, panca  
Panel, base D 600, bench



Interno base e contenitore sospeso  
Internal base and suspended unit



Basi e contenitori sospesi P 450  
Bases and suspended units D 450



Mensola in vetro  
Glass shelf

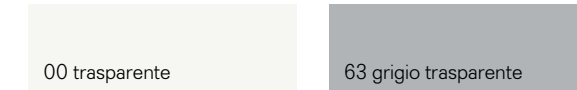

Vetrina  
Showcase

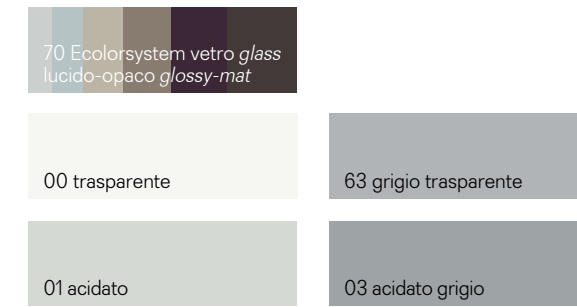

Anta scorrevole  
Sliding door



# Storage systems

186 Cover, 204 Cover freestanding





Design Giuseppe Bavuso

## Cover

Closing system equipped with single-face hinged doors in glass or porcelain. The core of the Cover project is the uprights, fixed to the ceiling and to the floor, which gather the concealed hinges of the door and the exclusive integrated internal led lighting system. Shelves and drawers are fixed directly to the uprights without visible screws, which allows a free and easily interchangeable arrangement.

Sistema di chiusura attrezzato con ante battenti monofronte in vetro o grès. Fulcro del progetto Cover sono i montanti, fissati a soffitto e a pavimento, che raccolgono i cardini invisibili delle ante e l'esclusivo sistema integrato di illuminazione interna a led. Mensole e cassettiere vengono fissate ai montanti con un sistema ad incastro, senza viti a vista, che consente una disposizione libera e modificabile nel tempo con estrema facilità.

Dieses Verschlussystem ist mit einfach verglasten Türen aus Glas oder Grès versehen. Der Kern des Projekts Cover sind die Pfosten, die an der Decke und am Boden befestigt sind und die unsichtbaren Scharniere der Türen und das exklusive integrierte System der internen Led-Beleuchtung sammeln. Regale und Schubladen sind an den Pfosten mit einem Verriegelungssystem ohne sichtbare Schrauben befestigt, was eine freie und modifizierbare Anordnung mit extremer Leichtigkeit ermöglicht.

Système de fermeture équipé avec portes battante uniface en verre ou grès. Le cœur du projet Cover sont les montants, fixés au plafond et au sol, qui intègrent les charnières invisibles des portes et le système exclusif d'éclairage led à l'intérieur. Les étagères et les tiroirs sont fixés aux montants avec un système à encastrement, sans vis visibles, avec libre disposition, qui peut être facilement modifiée ensuite.

Sistema de cierre equipado con hojas batientes monofaciales en cristal o grès. El núcleo del proyecto Cover son los montantes, fijados al techo y al suelo, que recogen las bisagras invisibles de las puertas y el exclusivo sistema integrado de iluminación led interna. Los estantes y los cajones se fijan a los montantes con un sistema de enganche, sin tornillos visibles, que permite una disposición libre y modificable en el tiempo con extrema facilidad.

Struttura Structure: 30 alluminio  
 Ante Doors: 97 avorio opaco  
 Mensole Shelves: 63 grigio trasparente  
 Maniglia in pressofusione incassata filo anta  
 High pressure die-casting recess handle  
 W 2300 H 2700 D 513

Nella foto In this photo  
 Tavolo Table: Manta

Cover è un sistema di ante battenti monofronte in vetro che possono essere utilizzate per chiudere gli ambienti dedicati alle cabine armadio o, in alternativa, per trasformare le nicchie in veri e propri armadi a muro.

Cover is a system of glass hinged doors, which can be used to close spaces dedicated to walk-in wardrobes or also to transform niches in real wall wardrobes.

Cover ist ein Flügeltürensysteem aus Glas nur auf einer Seite lackiert, um die Schrankräume zu schließen oder, alternativ, die Nischen in echte Schränke zu verändern.

Cover est un système de portes battantes unifaces en verre qui peuvent être utilisées pour fermer des espaces dédiés aux dressing ainsi que des niches, qui sont donc transformés en de vrais placards.

Cover es un sistema de hojas batientes de una sola cara en cristal que se pueden utilizar para cerrar ambientes finalizados a los vestidores o, en alternativa, para transformar pequeños espacios en armarios contra pared.











Concezione progettuale  
Design concept



Il progetto Cover rinnova la concezione progettuale della nicchia o dell'armadio a muro, trasformando le ante nell'unico elemento strutturale necessario a cui agganciare l'attrezzatura interna. Come tutti i sistemi Rimadesio, Cover è dotato di una serie di accorgimenti esclusivi, come i montanti muniti di un esclusivo sistema di regolazione invisibile in tre direzioni, che consente una perfetta messa in bolla delle ante, anche con composizioni di grandi dimensioni. L'attrezzatura completa del sistema Cover prevede basamenti, mensole, aste portabiti, ripiani estraibili e cassettiere. Tutti gli elementi vengono fissati ai montanti con un sistema ad incastro, senza viti a vista, e la disposizione può essere modificata e variata nel tempo con estrema facilità.

The Cover project renews the design concept of the niche or wardrobe, transforming the doors in the one and only structural element, necessary to fix the internal equipment. As all Rimadesio systems, Cover presents some exclusive features, such as the uprights equipped with a three direction invisible adjustment system, that allows a perfect leveling of the doors, even with compositions of large dimensions. Cover system accessories include floor bases, shelves, cloth-hanger rods, pull out shelves and drawer units. All the elements are fixed directly to the uprights, without visible screws, and the layout can be modified any time in an easy way.

Das Projekt erneuert das Konzept der Nische oder den Schrankraum. Die Türen sind die einzige strukturelle Elemente wo wird die Innenausstattung fixiert. Wie alle Rimadesio Systeme hat Cover eine exklusive System mit Pfosten, die eine perfekte Nivellierung der Türen erlaubt, auch mit großen Kompositionen. Die Ausstattung des Systems Cover bietet Basisboden, Fachboden, Kleiderstange ausziehbar, Fachboden und Schubladenelemente an. Alle Elemente sind an den Pfosten befestigt mit einem Verbindungssystem ohne sichtbare Schrauben und die Verstellung kann im Laufe der Zeit leicht verändert werden.

Le projet Cover renouvelle la conception d'équiper une niche ou un placard en transformant les portes dans le seul élément structurel nécessaire auquel fixer tous les accessoires à l'intérieur. Comme tous les autres systèmes Rimadesio, Cover est doté d'une série de détails exclusifs, comme les montants, équipés d'un système invisible exclusif de réglage en trois directions, qui permet une parfaite mise à niveau des portes, même avec des grandes compositions. L'équipement complet du système Cover comprend bases au sol, étagères, tiges porte-manteaux, étagères extractibles et bloc tiroirs. Tous les éléments sont fixés aux montants avec un système à encastrement sans vis visibles et la disposition peut être facilement modifiée ensuite.

El proyecto Cover renueva la concepción de proyecto de los espacios pequeños o del armario contra pared, transformando las hojas en el único elemento estructural necesario a los cuales enganchar el equipo interior. Como todos los sistemas Rimadesio, Cover está dotado de una serie de recursos exclusivos, como los montantes que tienen un exclusivo sistema de regulación invisible en tres direcciones, que permiten una perfecta nivelación de las hojas, también en composiciones de grandes dimensiones. El equipo completo del sistema Cover proporciona soportes, estantes, barras colgantes, estantes extraíbles y cajoneras. Todos los elementos se fijan a los montantes con un sistema a encaje, sin tornillos a vista, y la disposición se puede modificar y variar en el tiempo con facilidad extrema.

Caratteristiche tecniche esclusive  
Exclusive technical features

Elementi strutturali  
Structural elements

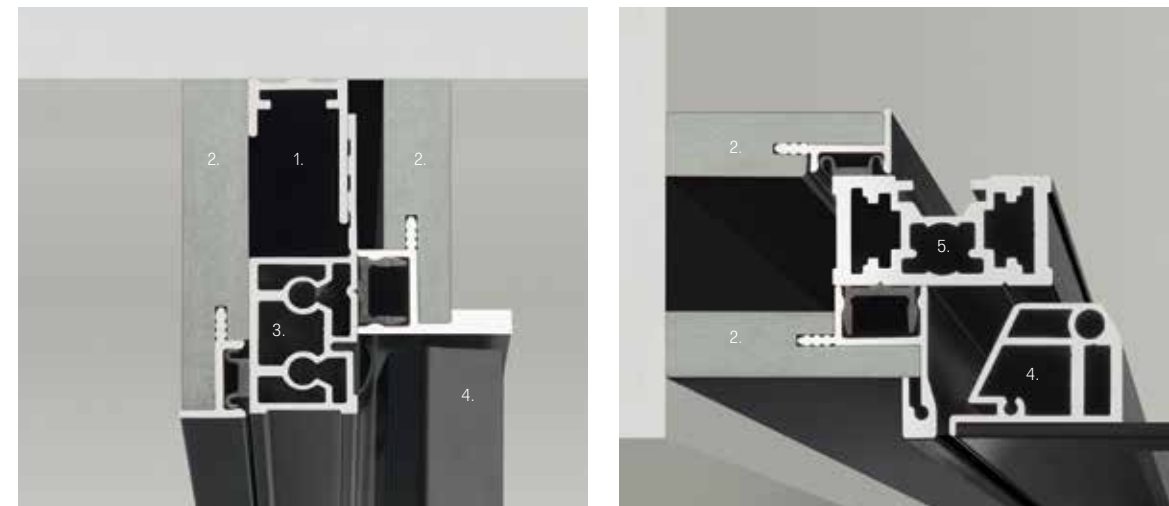

1. Profilo di aggiustaggio a soffitto in estruso di alluminio. Consente la perfetta messa in bolla del traverso e di compensare gli eventuali dislivelli del soffitto. / Ceiling adjusting profile in extruded aluminium. It allows a perfect leveling of the upright and to compensate any possible unevenness of the ceiling.
2. Fasce di aggiustaggio con profilo di supporto in estruso di alluminio e fascia di compensazione in mdf laccato adattabile al vano. Esclusivo sistema di aggancio a scomparsa in nylon. / Fillers with supporting profile in extruded aluminium and adjustment filler in lacquered mdf perfectly adaptable to the opening. Unique concealed nylon fixing system.
3. Traverso strutturale in estruso di alluminio, dotato di magneti di chiusura e di guarnizione di battuta in pvc per un movimento di chiusura ammortizzato. Structural crosspiece in extruded aluminium, equipped with closing magnets and perimetric joint in pvc, which allows a soft and silent closing.
4. Pannello porta, struttura in estruso di alluminio e vetro singolo frontale temperato spessore 4 mm. Guarnizione di chiusura in pvc. / Panel door with extruded aluminium structure and single tempered front glass thickness 4 mm. Closing joint in silicone rubber.
5. Montante strutturale in estruso di alluminio, accessoriabile con illuminazione a led opzionale. Cerniera incassata brevettata con regolazione micrometrica. Extruded aluminium structural runner, which can be equipped with optional led lighting system. Patented recess hinges which allow a micrometric adjusting.

Sistema di fissaggio degli accessori  
Accessories fixing system



Tutti gli accessori vengono fissati ai montanti con un sistema ad incastro, senza viti a vista, e la disposizione può essere modificata e variata nel tempo con estrema facilità. All the elements are fixed directly to the uprights, without visible screws, and the layout can be modified any time in an easy way.

Maniglie  
Handles



1.

2.

1. 2013 maniglia in pressofusione di zama incassata a filo struttura. / Die-casting aluminium handle.
2. 2014F / 2014C maniglia in pressofusione di zama con serratura e chiave. Die-casting aluminium handle with lock and key.

**Tipologie compositive**  
Different compositions

Ante battenti  
Hinged doors

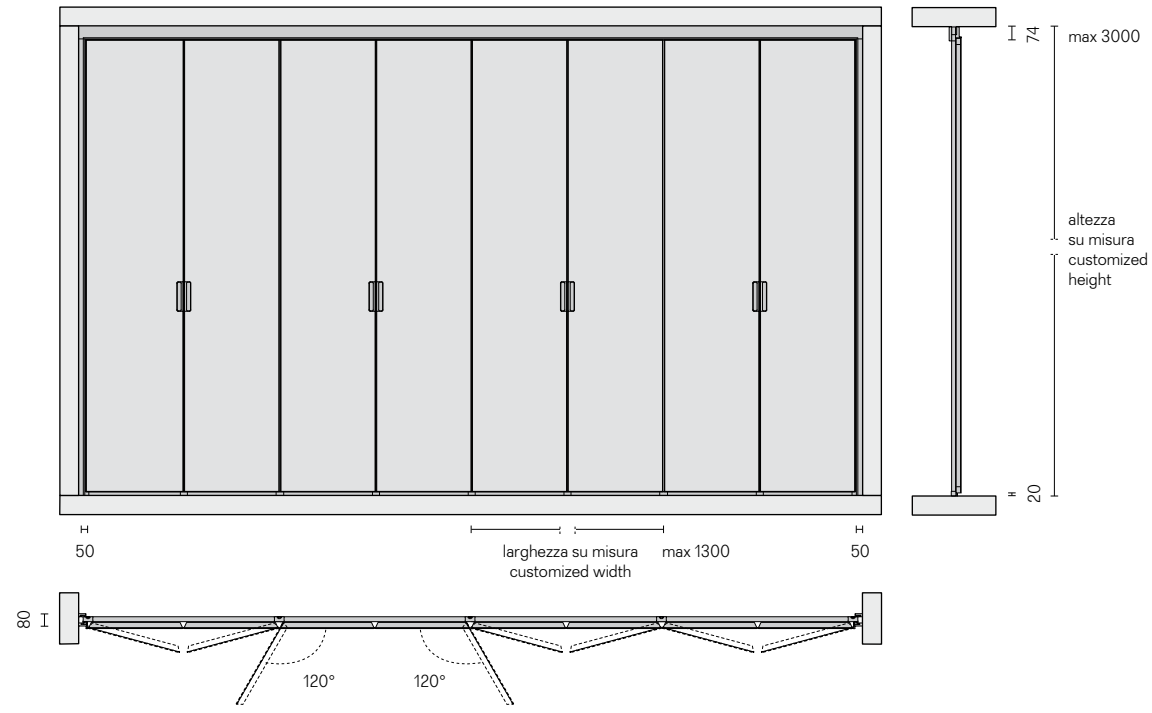

Ante battenti con attrezzatura interna  
Hinged doors with internal equipment

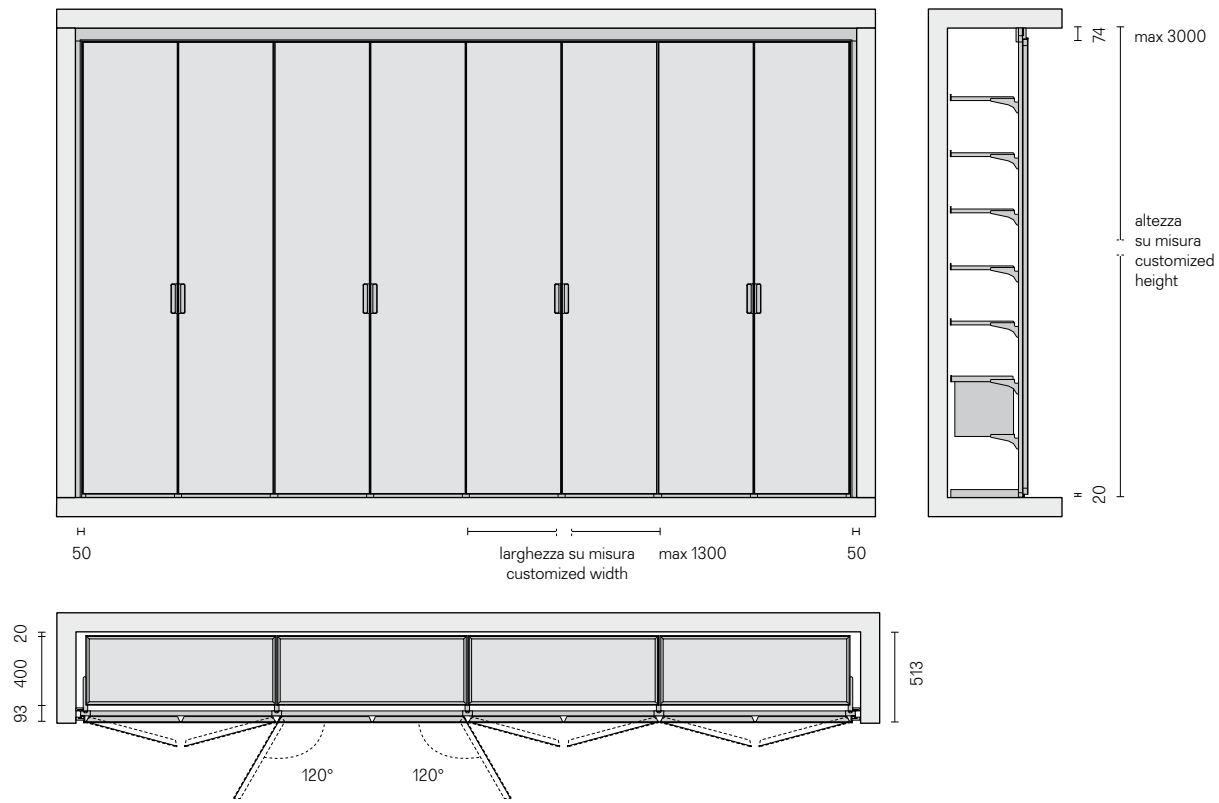

**Possibilità di utilizzo**  
Possible compositions

Composizione a muro  
Wall composition

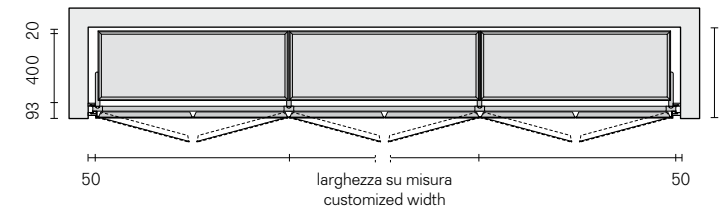

Composizione lineare con fianchi finali  
Linear composition with terminal sides

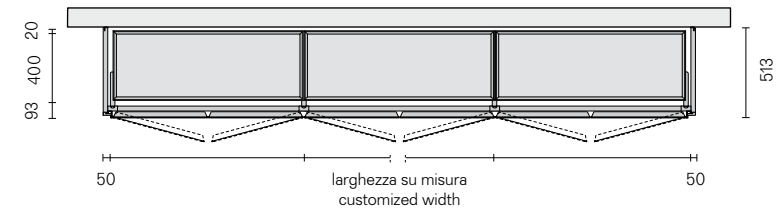

Composizione ad angolo  
Corner composition

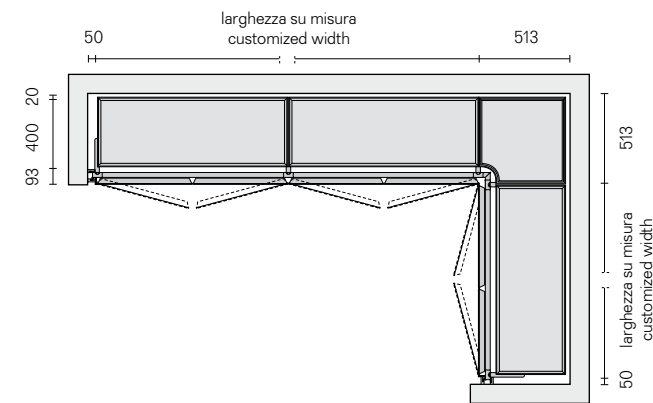

Composizione ad angolo esterno  
Composition with external corner

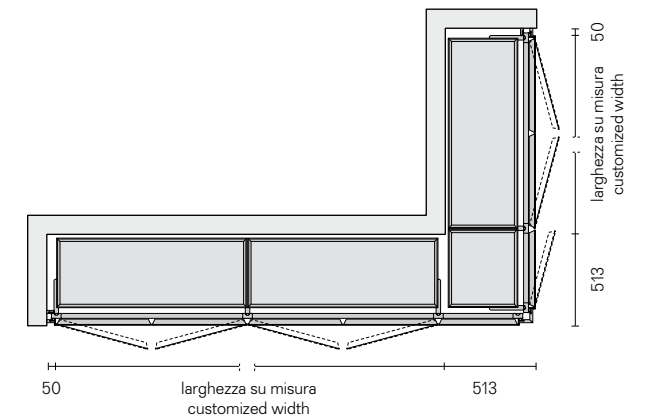

Composizione a C  
C-shaped composition

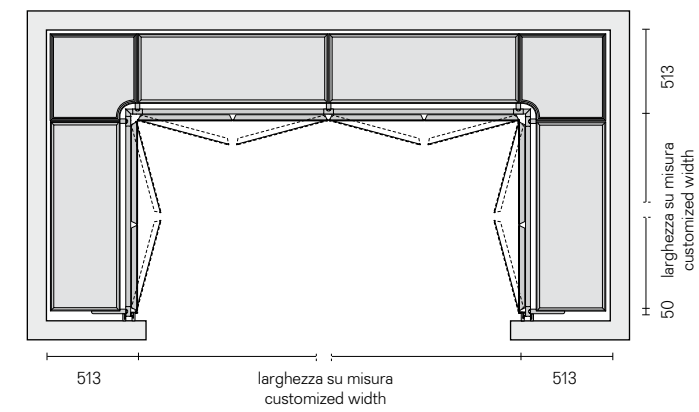

Nicchia attrezzata  
Equipped niche

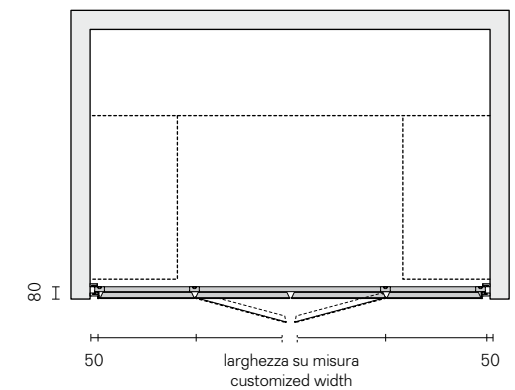



**Modularità e componenti**  
Modularity and components

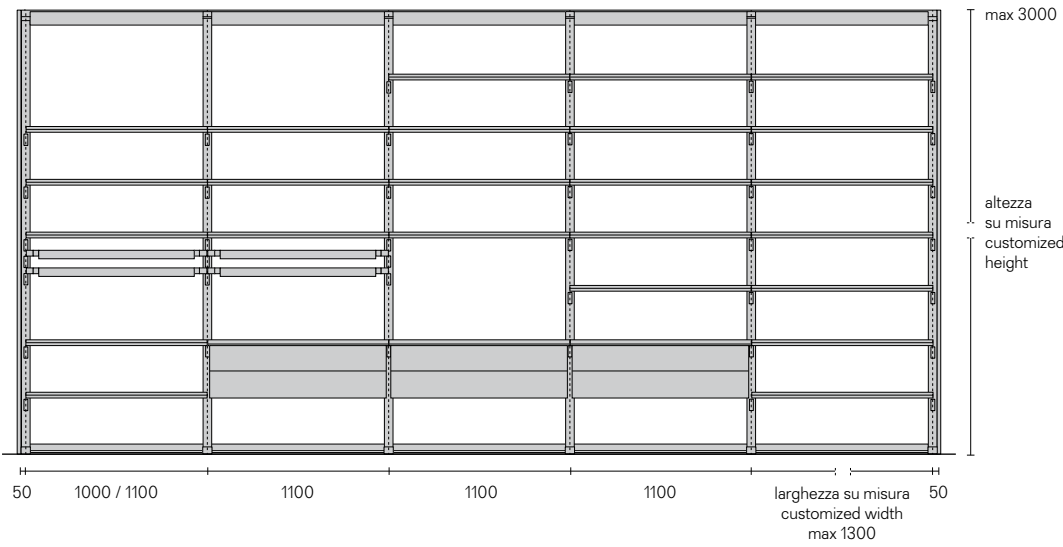

Anta battente con struttura in estruso d'alluminio, vetro temperato o gres spessore 4 mm. Chiusura con chiave opzionale / Hinged panel door with extruded aluminium structure and tempered glass or porcelain thickness 4 mm. Key lock on request

Fianco finale in legno laccato Terminal panel in lacquered wood

Montante strutturale in estruso di alluminio con illuminazione led opzionale. Profilo di aggiustaggio a soffitto e traverso strutturale / Structural runner in extruded aluminium, also available with an internal led lighting system. Ceiling adjusting profile and structural crosspiece

Fasce di aggiustaggio laterali e superiori, anteriori e posteriori / Lateral and upper, front and back fillers

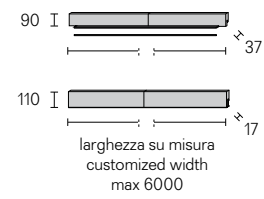
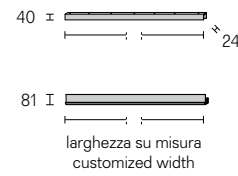
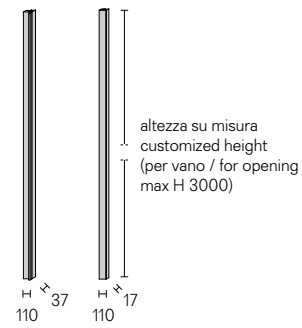
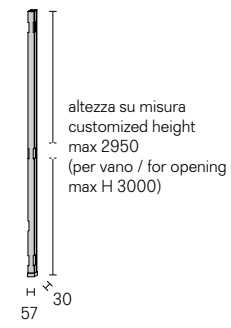
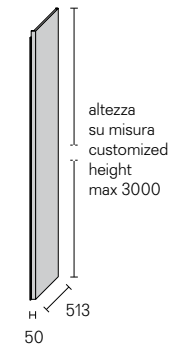
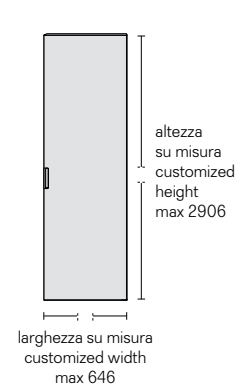

**Accessori**  
Accessories

Ripiano estraibile con vaschetta in similpelle / Pull out shelf with tray in synthetic leather finishing

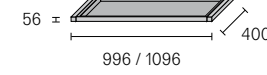

Contenitore in essenza di noce Walnut veneered organizer

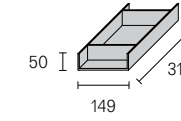

Separatore doppio Organizer with double partition

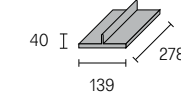

Porta orologi / Watch holder

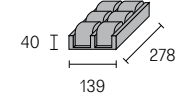

Vaschetta concava e vaschetta con fessure / Concave box and box with jewels slots

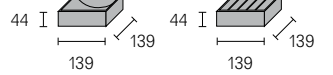

Basamento in legno laccato o in melaminico / Floor base in lacquered wood or melamine

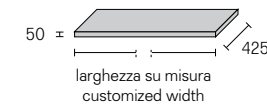

Mensola in melaminico con profilo posteriore in alluminio. Melamine shelf with rear aluminium profile.

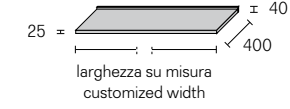

Mensola in vetro con ring in alluminio e top opzionale in similpelle / Glass shelf with aluminium ring and optional top in synthetic leather finishing

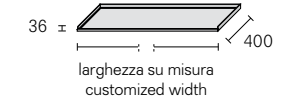

Cassettiera sospesa in legno laccato o melaminico, top in specchio grigio. Top opzionale in similpelle / Suspended drawer unit in lacquered wood or melamine, top in gray mirror. Optional top in synthetic leather

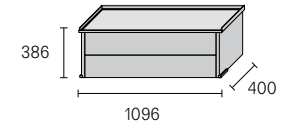

Cesta e vassoio in cuoio rigenerat / Synthetic leather box and tray

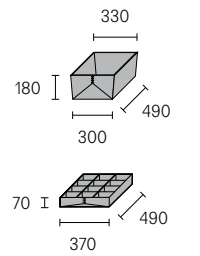

Possibilità estetiche  
Aesthetical options

Alluminio nero  
Black aluminium



1. Montante strutturale in alluminio nero. / Black aluminium structural upright.
2. Guarnizione in pvc nero. / Black pvc joint.
3. Anta battente con struttura in alluminio nero, guarnizione in pvc nero. / Hinged door with black aluminium structure, black pvc joint.
4. Fasce di aggiustaggio in mdf laccato nero. / Black lacquered mdf fillers.

Alluminio brown, piombo, bronzo o platino  
Brown, piombo, bronzo or platino aluminium



1. Montante strutturale in alluminio brown, piombo, bronzo o platino. / Structural upright in aluminium brown, piombo, bronzo or platino.
2. Guarnizione in pvc nero. / Black pvc joint.
3. Anta battente con struttura in alluminio brown o piombo, guarnizione in pvc nero. / Hinged door with brown or piombo aluminium structure, black pvc joint.
4. Fasce di aggiustaggio in mdf laccato brown o piombo. / Filler in brown or piombo mdf.

Alluminio anodizzato  
Anodized aluminium



1. Montante strutturale in alluminio anodizzato. / Anodized aluminium structural upright.
2. Guarnizione in pvc grigio. / Grey pvc joint.
3. Anta battente con struttura in alluminio anodizzato, guarnizione in pvc grigio. / Hinged door with anodized aluminium structure, grey pvc joint.
4. Fasce di aggiustaggio in mdf laccato alluminio. / Aluminium lacquered mdf fillers.

Laccato Ecolarsystem 34 colori  
34 colors Ecolarsystem lacquered



1. Montante strutturale in alluminio anodizzato, nero, brown o piombo. / Structural upright in anodized aluminium, black, brown or piombo.
2. Guarnizione in pvc grigio o nero. / Grey or black pvc joint.
3. Anta battente con struttura in alluminio anodizzato, nero, brown o piombo. / Hinged door in anodized aluminium, black, brown or piombo structure. Grey or black pvc joint.
4. Fasce di aggiustaggio in mdf laccato nei 34 colori Ecolarsystem. / Mdf fillers lacquered in 34 Ecolarsystem colours.

**Finiture  
Finishings**

Struttura  
Structure

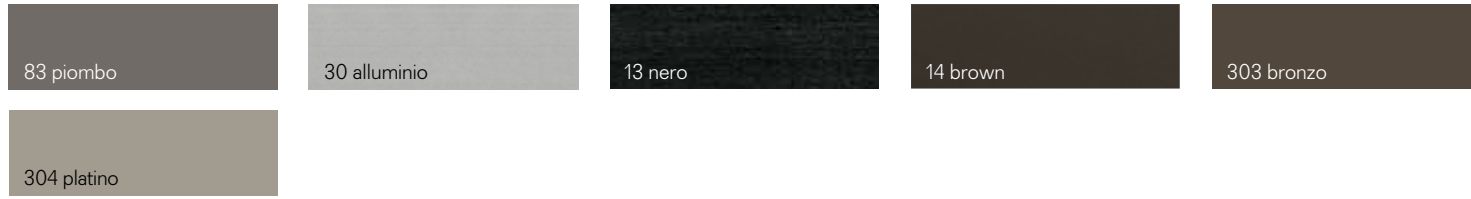

Fascia di aggiustaggio e fianco finale  
Filler and side panel



Basamento  
Floor base

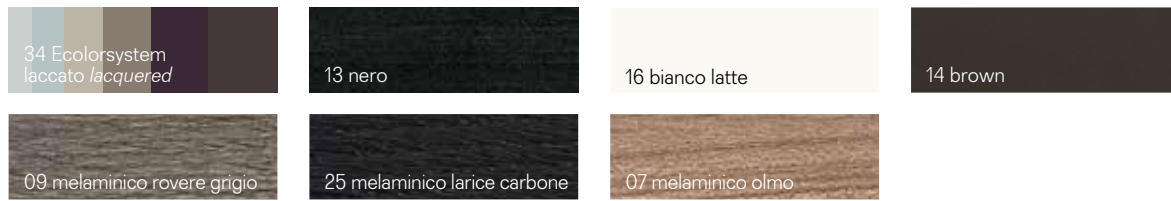

Cassettera sospesa  
Suspended drawer unit

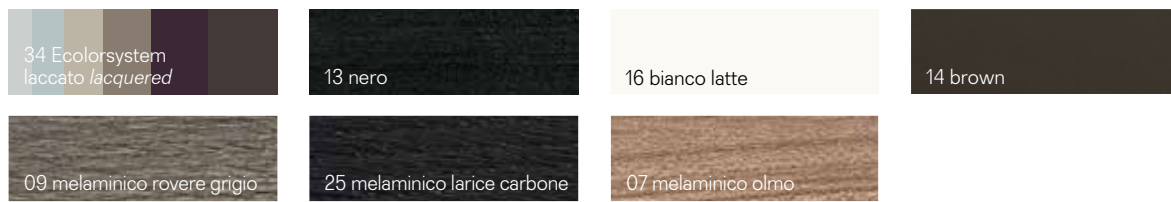

Interno cassetto  
Internal drawer

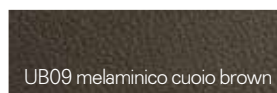

Mensola rivestita in cuoio  
Shelf covered with leather



Mensola in melaminico  
Melamine shelf



Mensola in vetro  
Glass shelf

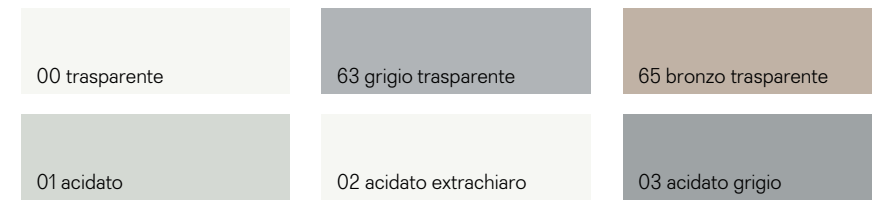

Anta  
Door

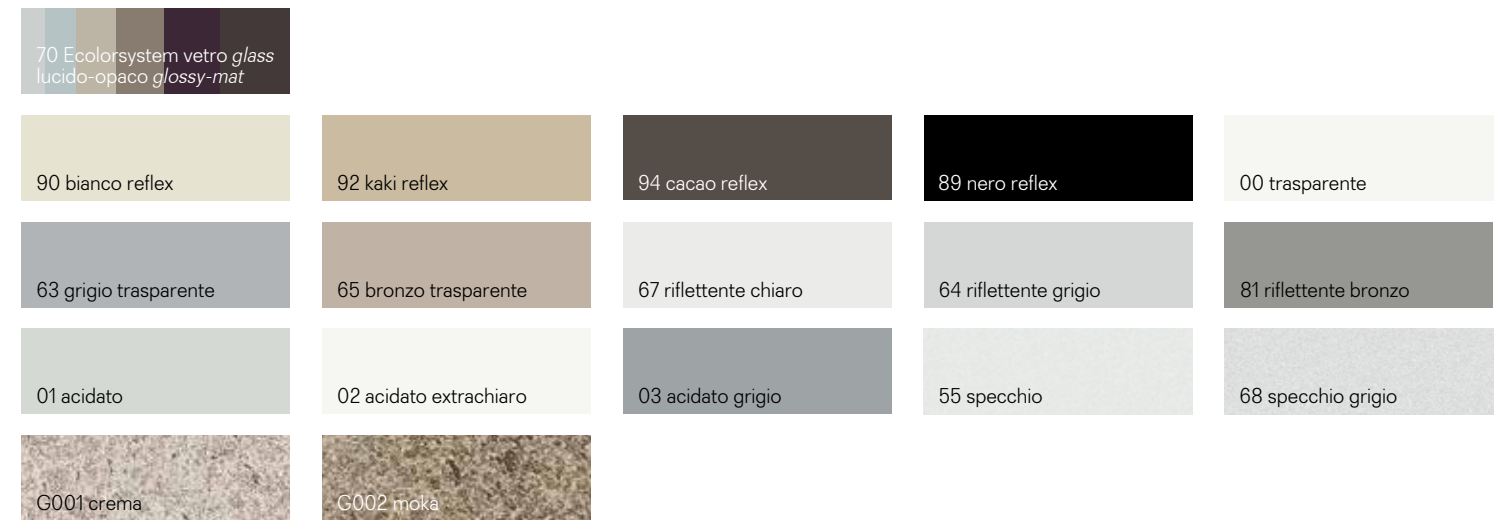





Design Giuseppe Bavuso

## Cover freestanding

Cover freestanding is the self-supporting version of the Cover system, therefore equipped with side and back panels to allow the definition of always tailored linear or corner compositions. The perfect finishing of the backpanels and of the inside of the doors make Cover freestanding an ideal system also for niche solutions, also combined with integrated through-way. The internal structures are fixed directly to the uprights without visible screws, which allows a free and easily interchangeable arrangement.

Cover freestanding è la versione autoportante del sistema Cover, dotato quindi di fianchi laterali e pannelli schienali per consentire la definizione di composizioni lineari o con angoli, sempre a misura. La perfetta finitura degli schienali e dell'interno delle ante rendono Cover freestanding un sistema ideale anche per soluzioni interparete, completo di passaggi integrati. Le attrezzature interne vengono fissate ai montanti con un sistema ad incastro, senza viti a vista, che consente una disposizione libera e modificabile nel tempo con estrema facilità.

Cover freestanding ist die selbsttragende Version des Cover Systems, das daher mit Seitenteilen und Rückwänden ausgestattet ist, um lineare oder eckige Kompositionen auf Maß zu definieren. Das perfekte Finish der Rückenlehnen und der Türinnenseiten macht Cover freestanding zu einem idealen System auch für Zwischenwandlösungen mit integrierten Durchgängen. Die inneren Befestigungen sind an den Pfosten mit einem Verriegelungssystem ohne sichtbare Schrauben befestigt, was eine freie und leicht modifizierbare Anordnung im Laufe der Zeit ermöglicht.

Cover freestanding est la version autoportante du système Cover, donc équipé de panneaux latéraux et de panneaux de fond pour permettre la définition de compositions linéaires ou en angle, toujours sur mesure. La finition parfaite des panneaux de fond et de l'intérieur des portes permettent à Cover de devenir un système idéal aussi pour les solutions inter-murs, avec des passages intégrés. Les équipements internes sont fixés aux montants avec un système à encastrement, sans vis visibles, avec libre disposition, qui peut être facilement modifiée ensuite.

Cover freestanding es la versión autoportante del sistema Cover, equipada por lo tanto de paneles laterales y paneles traseros para permitir la definición de composiciones lineales o en ángulo, siempre a medida. El perfecto acabado de los paneles traseros y del interior de las puertas hacen de Cover freestanding un sistema ideal también para soluciones entre paredes, completo de hueco de pasos. Los elementos accesorios internos se fijan a los montantes con un sistema de enganche, sin tornillos visibles, que permite una disposición libre y modificable en el tiempo con extrema facilidad.

Struttura Structure: 304 platino  
Vetro Glass: 67 riflettente chiaro  
Basamento e top Floor base and top: 09 melaminico rovere grigio  
Mensole Shelves: 63 grigio trasparente  
Cassettiere Drawers: 09 melaminico rovere grigio  
Top cassettiere Drawers top: 154 similpelle argilla

Nella foto In this photo  
Tavolo Table: Manta  
Tavolino Coffee table: Planet  
Porta Door: Moon





La varietà delle finiture dei vetri proposti nella collezione Rimadesio permette la definizione di configurazioni esteticamente differenti: dalla "teca" interamente trasparente all'armadiatura tradizionale con ante in vetro opaco o lucido e con inoltre la possibilità di combinazione con fianchi e schienali trasparenti o acidati per garantire agli interni una naturale luminosità.

The variety of finishes of glass offered in the Rimadesio collection allows the definition of aesthetically different configurations: from the entirely transparent "vitrine" to the traditional wardrobe with mat or glossy lacquered glass doors and with the possibility of combination with transparent or satined side and back panels, in order to ensure a natural brightness to the interior.

Die Vielzahl von Oberflächen der Rimadesio angebotene Glas Kollektion erlaubt die Definition von ästhetischen unterschiedlichen Konfigurationen: von dem Vorschlag einen völlig transparenten Schrankraum bis zum dem traditionellen Kleiderschrank mit Türen aus Glas, matt oder glänzend, und mit der Möglichkeit, Seiten und Rücken aus transparentem oder geatztem Glas zu ergänzen, um eine natürliche Helligkeit in der Innenaustattung zu versichern.

La variété des finitions de verre proposées dans la collection Rimadesio permet la définition de configurations esthétiquement différentes: de la "vitrine" entièrement transparente à un armoire traditionnel avec portes en verre laqué mat ou brillant et avec la possibilité de combinaison avec les côtés et les panneaux de fond en verre transparent ou acidé, qui assurent une luminosité naturelle à l'intérieur.

La variedad de acabados de los cristales propuestos en la colección Rimadesio permite definir estéticamente diferentes configuraciones: de la vitrina totalmente transparente al armario tradicional con puertas en cristal mate o brillante y con la posible combinación de los laterales y paneles traseros transparentes o acidados para garantizar al interior una luminosidad natural.





Concezione progettuale  
The design concept

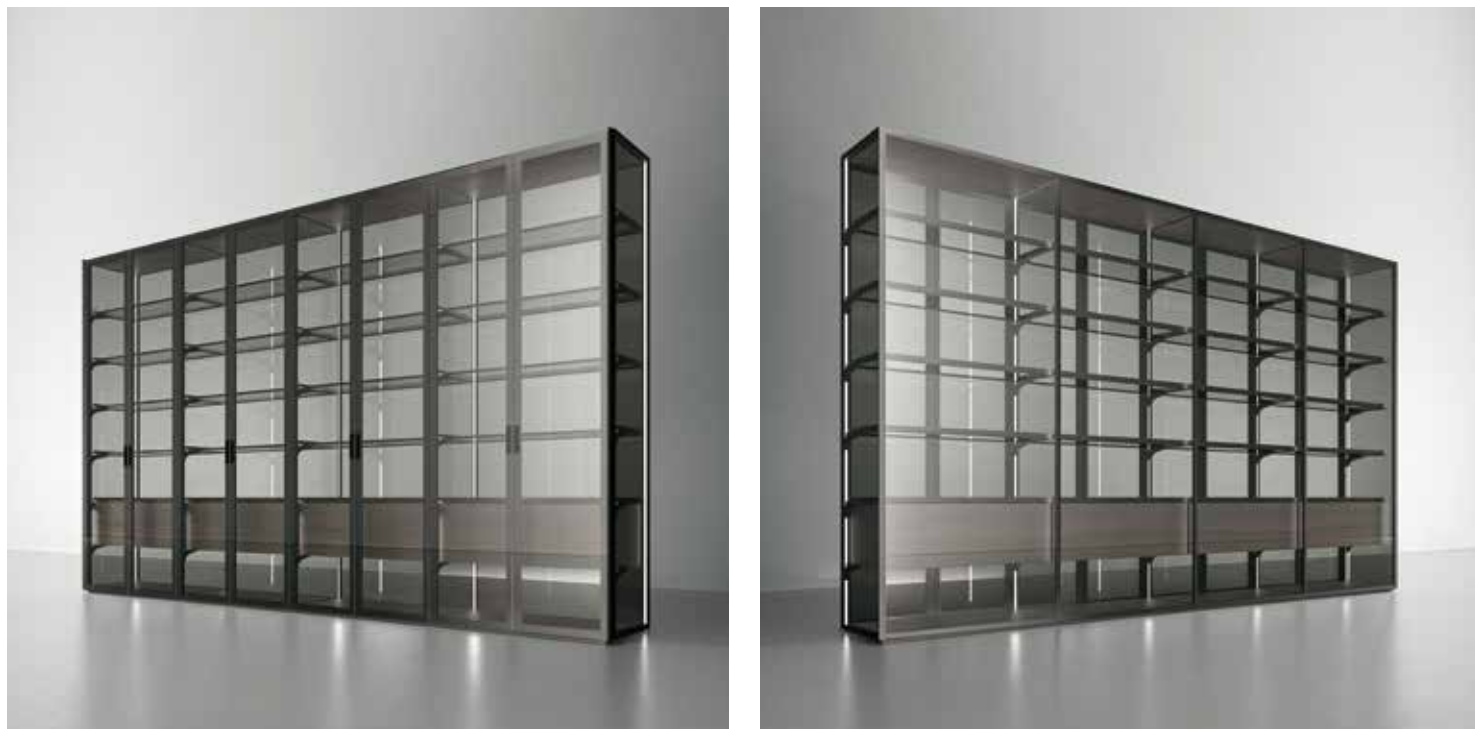

Un sistema armadio di ultima generazione, nel quale tutti i componenti, dalle ante agli accessori, dalla struttura ai complementi, sono realizzati su misura grazie a un sistema di produzione "custom-made". Le alte prestazioni di Cover freestanding nascono da una struttura in alluminio tecnologicamente innovativa. I montanti, su cui si regolano le ante ospitano l'illuminazione a led. Il sistema prevede la versione freestanding, con lato posteriore e fianchi completamente rifiniti, oppure la versione interparete, con fasce di aggiustaggio opzionali superiori e laterali, per chiudere gli eventuali fuori squadra delle pareti.

A storage system of the latest generation, where all components, from doors to accessories, from the structure to the complements, are custom-made. The high performances of Cover freestanding comes from a technological advanced aluminium structure. The uprights, on which the doors are adjusted, conceal the led lighting. The system provides the freestanding version, with sides and back panels completely well finished, or the version between the walls, with optional adjusting fillers for both sides and top, to close eventual differences in the wall.

Ein Schranksystem der nächsten Generation, in dem alle Komponenten, von den Platten bis zum Zubehör, von der Struktur bis zu den Zusätzen dank eines Produktionssystem individuell nach Maß gefertigt werden. Der hohe Leistungsumfang des Cover Freestanding ergibt sich aus einer technologisch innovativen Aluminiumstruktur. Die Stände, auf dem die Platten angepasst werden, verfügen über eine LED-Beleuchtung. Das System sieht die Version Freestanding mit vollständig geschlossenen Rückseiten und Seiten vor. Alternativ gibt es die Ausführung "interparete", mit optionaler obiger und seitlicher Einstellung der Wände.

Un système armoire de nouvelle génération, dans lequel tous les composants, des portes aux accessoires, de la structure aux compléments, sont fabriqués grâce à un système de production "sur mesure". Les hautes performances de Cover freestanding proviennent d'une structure en aluminium technologiquement innovante. L'éclairage led peut être installé sur les montants, qui réglent les portes. Le système est disponible en version freestanding avec l'arrière et les côtés complètement finis, ou en version entre murs avec fileurs latéraux et supérieurs optionnels, pour fermer les différences d'épaisseur de parois.

Un sistema armario de última generación, en el cual todos los componentes, de las puertas a los elementos accesorios, de la estructura hasta los complementos, son realizados a medida, gracias a un sistema de producción "custom-made". El alto rendimiento de Cover freestanding surgen de una estructura en aluminio tecnológicamente innovadora. Los montantes en los cuales se ajustan las puertas acomodan una iluminación por leds. El sistema prevé la versión freestanding, con parte trasera y paneles laterales completamente acabados, o la versión interpared, con bandas de ajuste opcionales superiores y laterales, para cerrar cualquier des-cuadre de las paredes.

Caratteristiche tecniche esclusive  
Exclusive technical features

Sistema di fissaggio degli accessori  
Accessories fixing system



Tutti gli accessori vengono fissati ai montanti con un sistema ad incastro, senza viti a vista, e la disposizione può essere modificata e variata nel tempo con estrema facilità. All the elements are fixed directly to the uprights, without visible screws, and the layout can be modified any time in an easy way.

Maniglie  
Handles

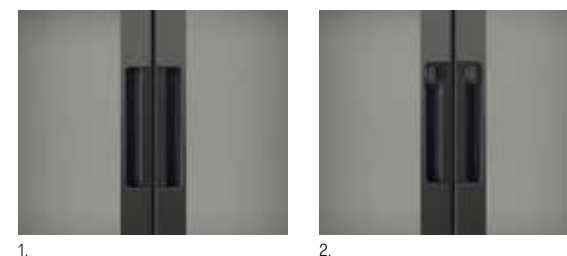

1. 2013 maniglia in pressofusione di zama incassata a filo struttura. / Die-casting aluminium handle.
2. 2014F / 2014C maniglia in pressofusione di zama con serratura e chiave. Die-casting aluminium handle with lock and key.

Tipologie compositive  
Different compositions

Centro stanza  
Middle room

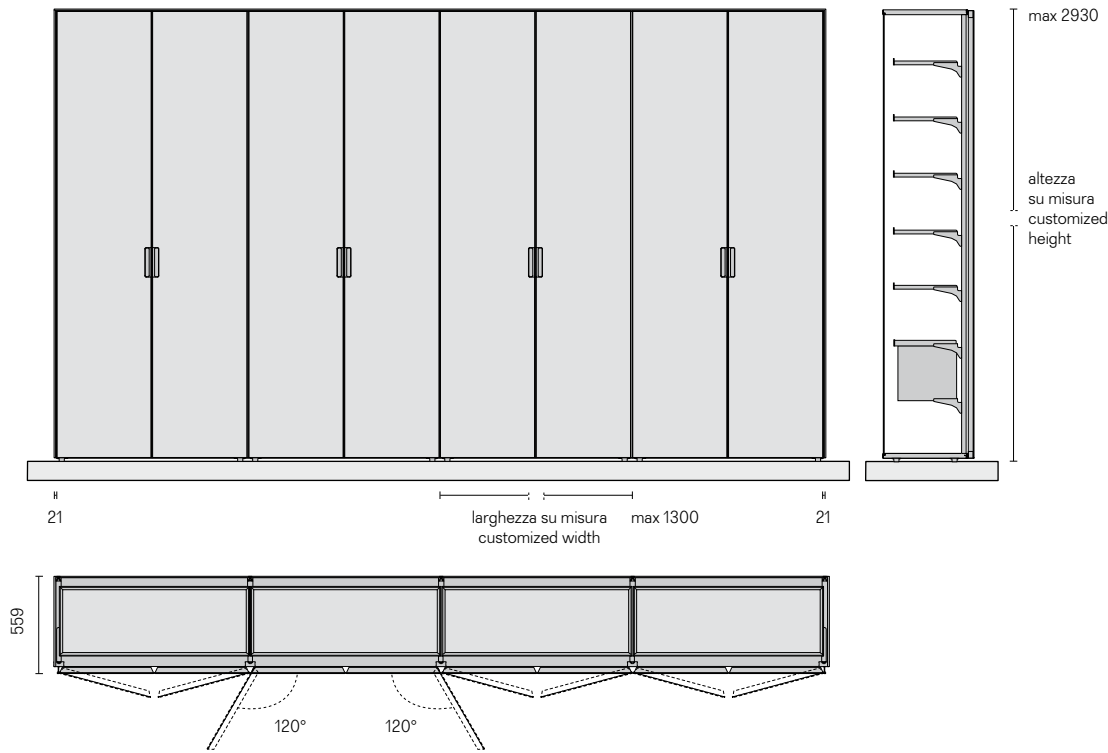

Interparete  
Niche

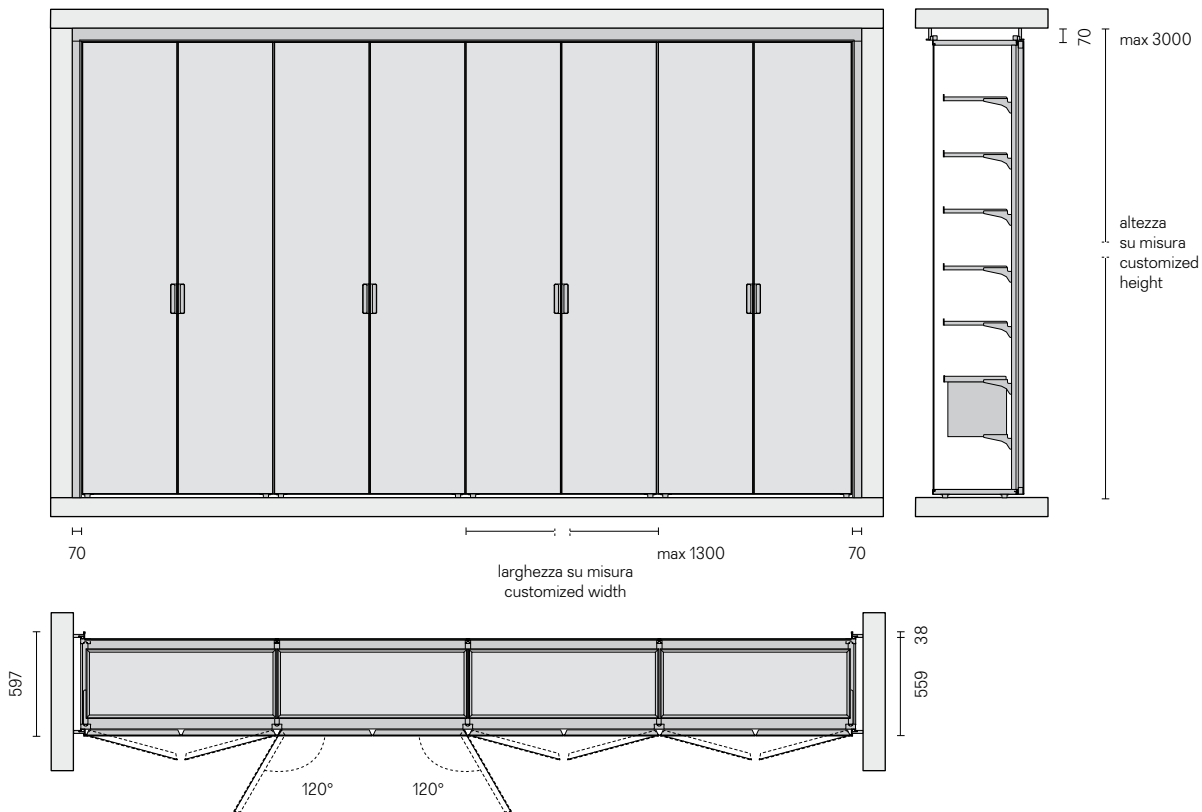

Possibilità di utilizzo  
Possible compositions

Composizione centro stanza  
Freestanding composition

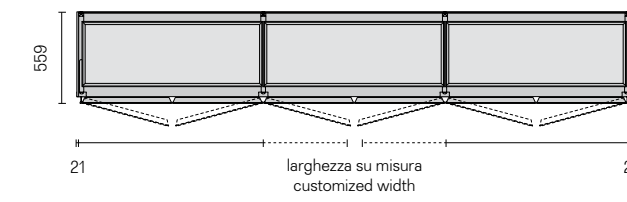

Composizione interparete  
Composition next to the wall

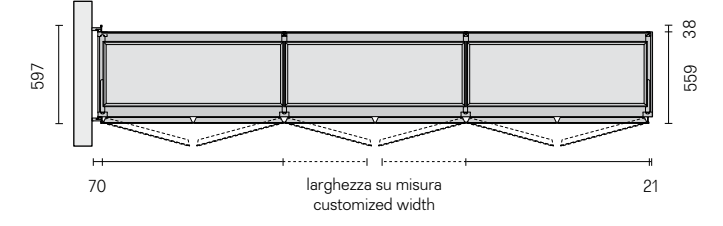

Composizione interparete con vano di passaggio  
Niche composition with through-way

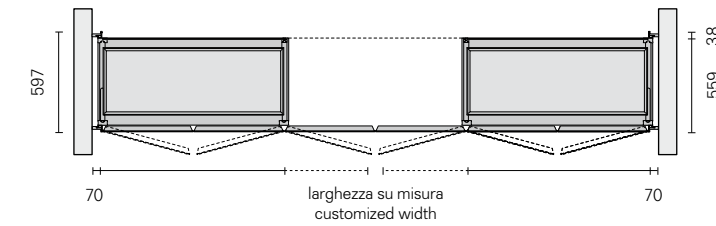

Composizione interparete con vano di passaggio e ante contrapposte  
Niche composition with through-way and counterposed doors

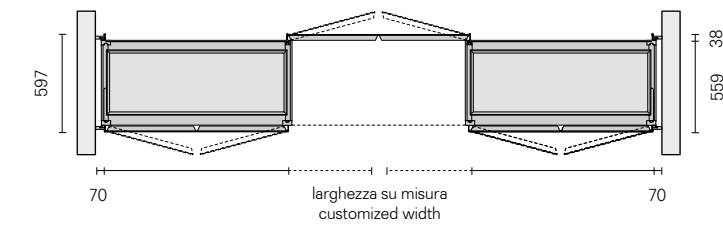

Composizione interparete con vano di passaggio laterale  
Composition in niche with side through-way

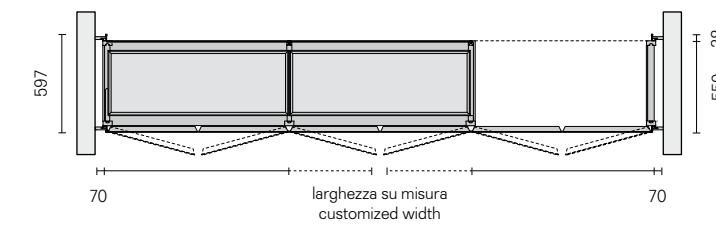

Composizione interparete con vano di passaggio laterale e ante contrapposte  
Composition in niche with through-way and counterposed doors

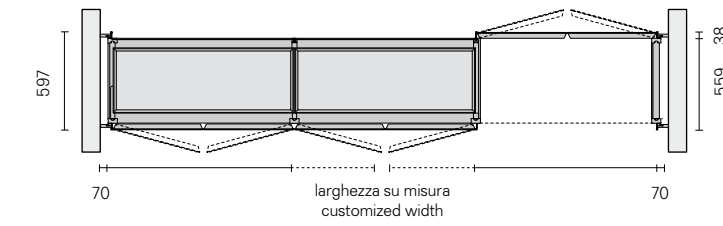

Composizione ad angolo  
Corner composition

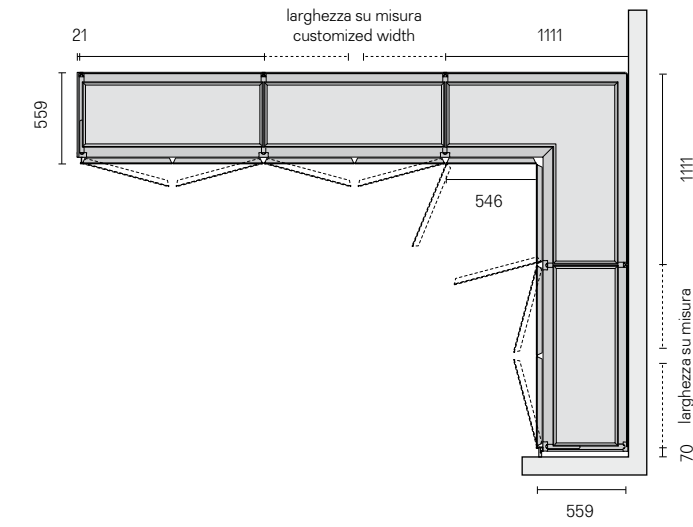

Composizione a c  
C shaped composition

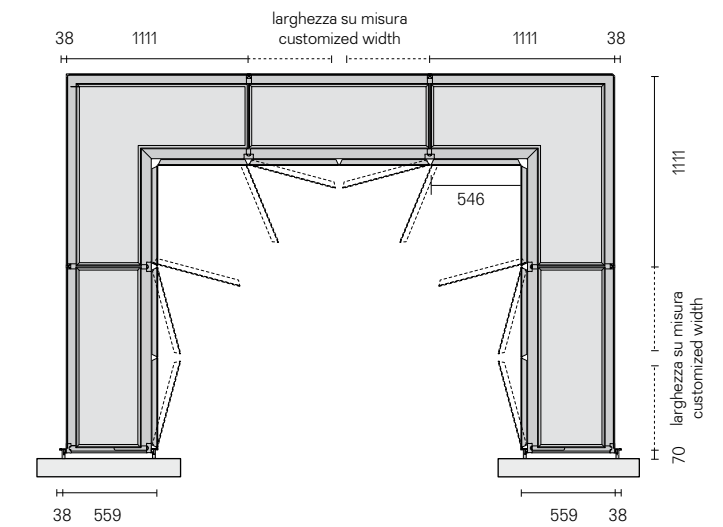

**Modularità e componenti**  
Modularity and components

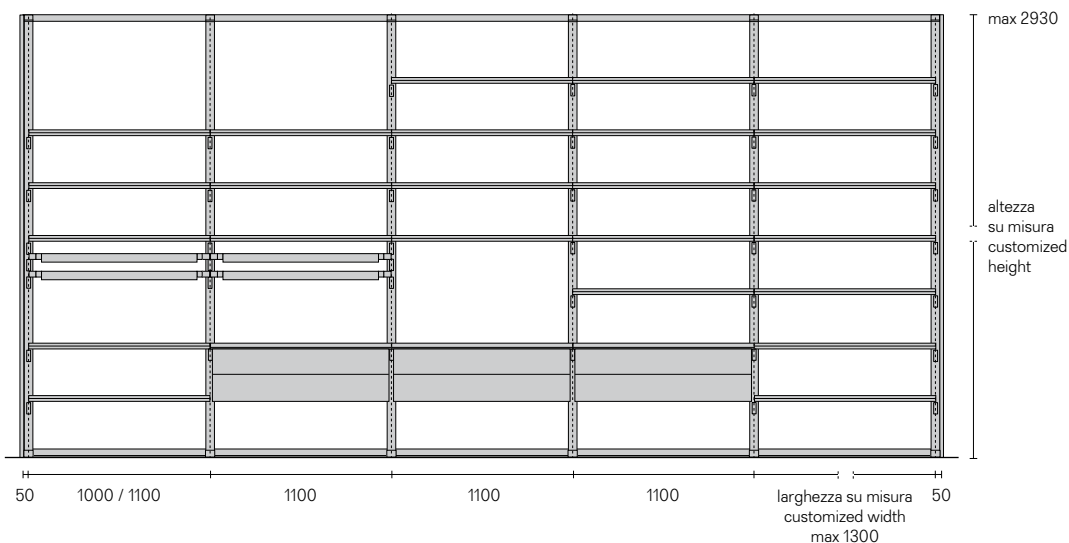

Anta battente con struttura in estruso d'alluminio, vetro singolo frontale temperato spessore 4 mm. Chiusura con chiave opzionale / Hinged panel door with extruded aluminium structure and single tempered front glass thickness 4 mm. Key lock on request

Fianco finale sp 48 mm, fianco intermedio sp 53 mm e fianco di passaggio sp 53 mm. Illuminazione a led opzionale anteriore e posteriore / Closing side panel thickness 48 mm, intermediate side panel thickness 53 mm and side panel for through-way thickness 53 mm. Optional front and rear led lighting system

Basamento e top in melaminico / Floor base and top in melamine

Schienale in vetro temperato spessore 6 mm, disponibile nei vetri laccati, trasparenti e satinati / Back panel in tempered glass thickness 6 mm, available in lacquered, transparent and satin glass

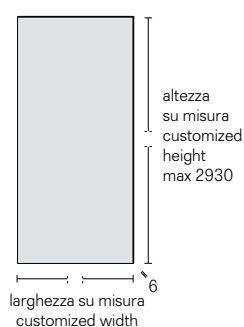
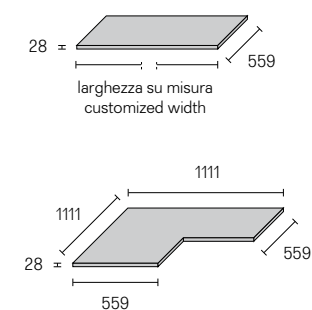
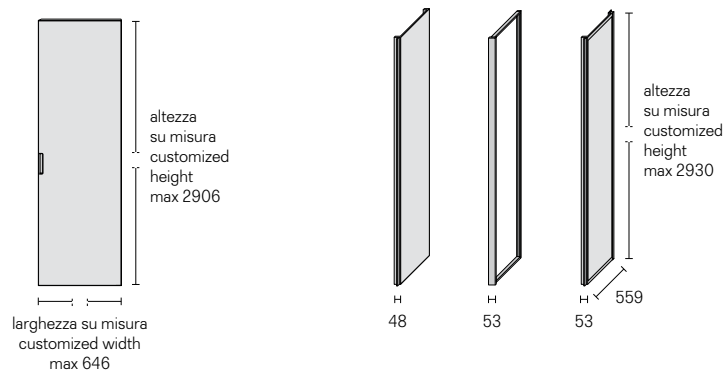

**Componenti**  
Components

Ripiano estraibile con vaschetta in similpelle / Pull out shelf with tray in synthetic leather finishing

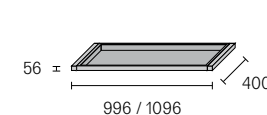

Contenitore in essenza di noce / Walnut veneered organizer

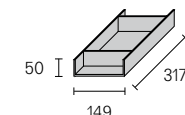

Separatore doppio / Organizer with double partition

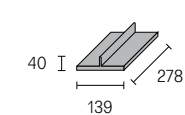

Porta orologi / Watch holder

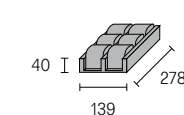

Vaschetta concava e vaschetta con fessure / Concave box and box with jewels slots

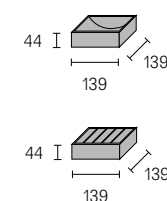

Cesta e vassoio in similpelle / Regenerated leather box and tray

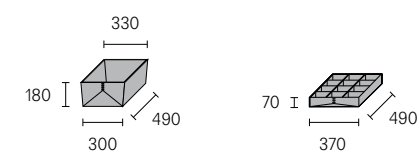

Fasce di aggiustaggio laterali e superiori, anteriori e posteriori / Lateral and upper, front and back fillers

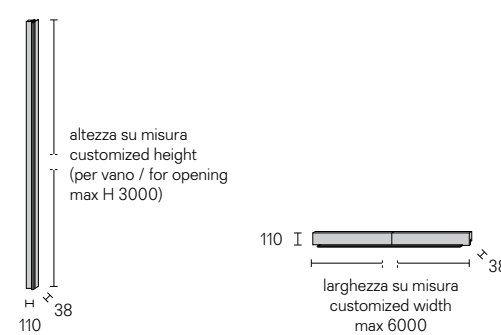

Mensola in melaminico con profilo posteriore in alluminio / Melamine shelf with rear aluminium profile

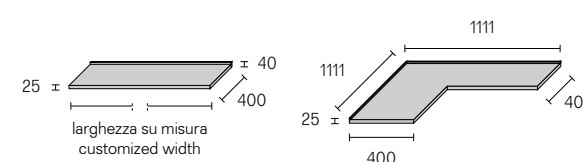

Mensola in vetro con ring in alluminio e top opzionale in similpelle / Glass shelf with aluminium ring and optional top in synthetic leather finishing

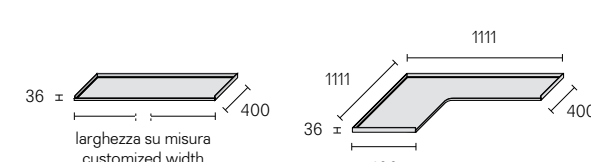

Cassettera sospesa in legno laccato o melaminico, top in specchio grigio. Top opzionale in similpelle / Suspended drawer unit in lacquered wood or melamine, top in gray mirror. Optional top in synthetic leather

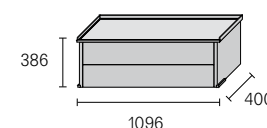



**Finiture**  
**Finishings**

Struttura e accessori  
Structure and accessories

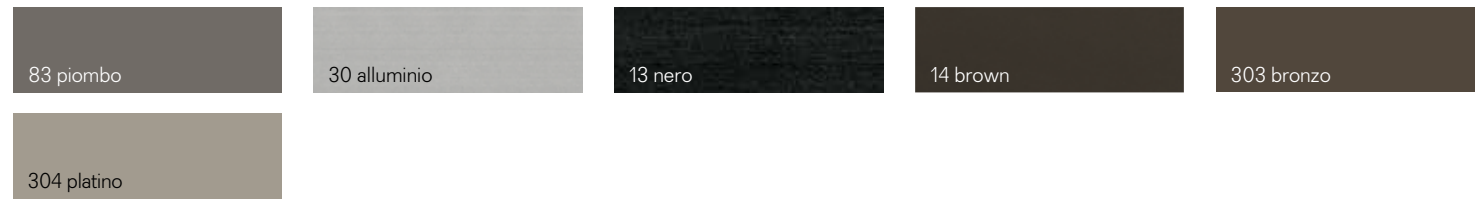

Fascia di aggiustamento  
Filler

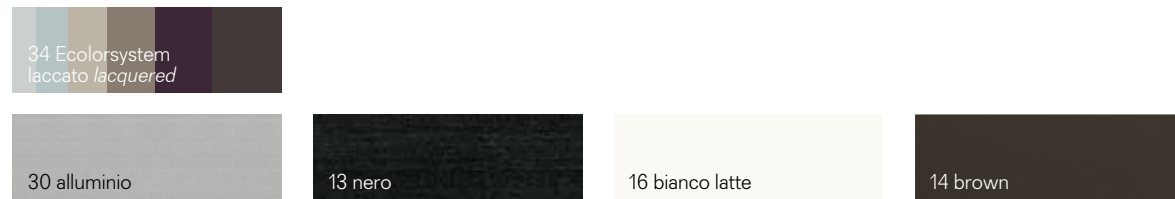

Basamento e top  
Floor base and top



Cassettiera  
Drawer Unit



Cassettiera sospesa  
Drawer Unit



Interno cassettera  
Internal drawer

Mensola in vetro  
Glass shelf

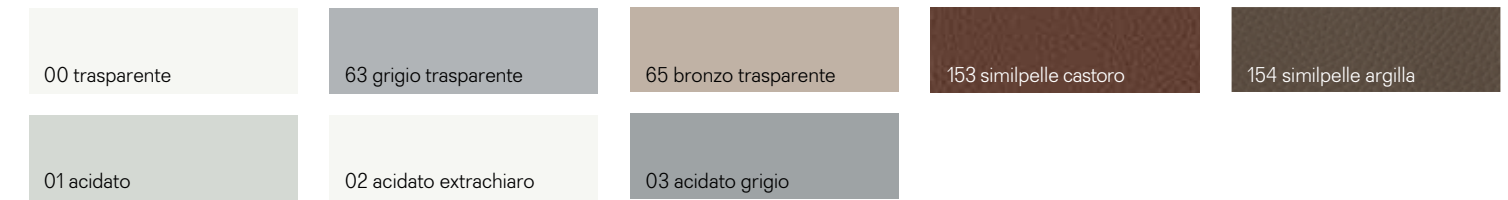

Ripiano estraibile e rivestimento asta portabiti  
Pull out shelf and cloth hanger bar

Mensola rivestita in cuoio  
Shelf covered with leather



Mensola in melaminico  
Melamine shelf



Anta, fianco, schienale  
Door, side, back panel



\* Disponibile solo per anta / Only available for door

Asta portabiti e reggimensola  
Cloth hanger and shelf holder

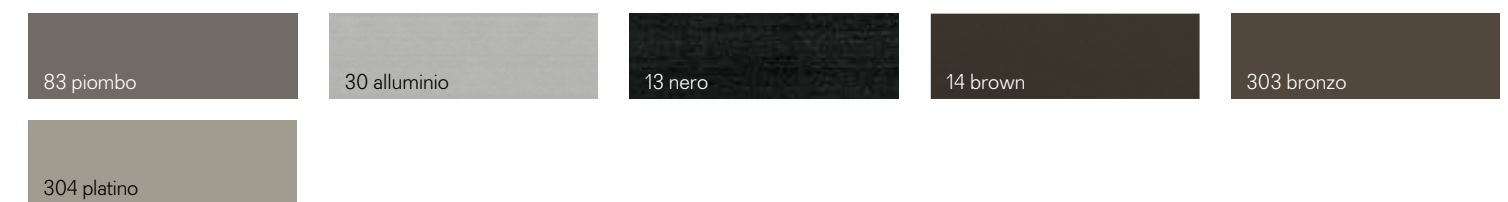

Perseguire la qualità, sempre, sotto tutti gli aspetti. Con questa mission Rimadesio ricerca costantemente soluzioni volte a migliorare i propri standard qualitativi ecologici. Obiettivo ottenuto sinergicamente, grazie all'utilizzo di materiali preziosi e riciclabili, all'assenza di sostanze tossiche per l'uomo e nocive per l'ambiente in ogni fase del processo produttivo,

Streben nach Qualität, unter allen Gesichtspunkten. Mit dieser Mission forscht Rimadesio ständig nach ökologischen Lösungen. Ein Ziel, welches sich aus Synergien ergibt, dank der Verwendung von hochwertigen und recycelbaren Materialien, dem Ausschluss von für den Menschen giftigen und umweltschädlichen Substanzen und den Antrieb der Produktions-

Poursuivre la qualité, toujours, et à tous les égards. Avec cette mission Rimadesio recherche constamment de solutions au fin d'améliorer ses normes de qualité écologique. Objectif atteint, grâce à l'utilisation de matériaux précieux et recyclables, l'absence à chaque étape de la production de substances toxiques nocives pour l'homme et l'environnement, l'utilisation de technologies

Perseguir la calidad, siempre, en todos los aspectos. Con esta misión Rimadesio busca constantemente soluciones destinadas a mejorar sus estándares de calidad ecológica. Objetivo conseguido sinérgicamente, gracias al uso de materiales preciosos y reciclables, a la ausencia de sustancias tóxicas para los seres humanos y nocivas para el medio ambiente en cada etapa

## Quality as main purpose, always and in every aspect. With this mission Rimadesio is constantly searching for solutions to improve its own ecological standards.

all'impiego di tecnologie e macchinari evoluti alimentati con energia pulita proveniente da impianti fotovoltaici di ultima generazione, installati sulla copertura dell'headquarter di Giussano. Alluminio, vetro, legno, similpelle, materiali totalmente riciclabili e in parte già riciclati, ma anche le vernici prive di solventi di Ecoloursystem e i sistemi di imballaggio ecologici. Testimonianze di un dna green consolidato e di una coerenza trasversale, segnali di una continua attività di ricerca e di uno sguardo sempre proteso al futuro che si declina nell'innovazione tecnologica di sistemi, porte ed arredi, realizzati con la consapevolezza di voler affidare all'uomo solo attività dall'alto valore aggiunto.

anlagen mit sauberem Strom, welcher durch Photovoltaikanlagen neuester Generation erzeugt wird. Aluminium, Glas, Holz, Kunstleder, völlig recycelbare oder schon recycelte Materialien, aber auch die Lösungsmittelfreien Farben des Ecoloursystems und die umweltfreundlichen Verpackungsmaterialien. Alles Belege für eine fundierte grüne Dna und in einem übergreifenden Zusammenhang. Zeichen für eine kontinuierliche Forschungsaktivität und einen zukunftsorientierten Blick, die sich in den Innovationen der technischen Systemen, der Türen und Möbeln ausdrücken, welche mit dem Bewusstsein entwickelt werden, dem Menschen den größtmöglichen Zusatznutzen zu bieten.

et des machines avancées alimentées par l'énergie solaire après l'installation sur le toit de l'usine à Giussano de systèmes photovoltaïques de dernière génération. Aluminium, verre, bois, simili-cuir, des matériaux entièrement recyclables et déjà en partie recyclés, mais aussi peinture Ecoloursystem sans solvantset systèmes d'emballage respectueux de l'environnement. Témoignages d'un adn "vert" consolidé et d'une cohérence transversale, signes de recherche continue et d'une tendance à regarder en avant, qui correspond bien à l'innovation technologique des systèmes, des portes et des meubles, réalisés avec la conscience que l'apport de l'homme dans la production ne peut qu'avoir un valeur ajoutée.

del proceso de producción, al uso de tecnologías y máquinas avanzadas alimentadas por energía limpia a partir de sistemas fotovoltaicos de última generación, instalados en la cobertura del headquarter de Giussano. Aluminio, cristal, madera, similcuero, materiales completamente reciclables y, en parte, ya reciclados, sino también las pinturas Ecoloursystem libres de disolventes y los sistemas de embalaje ecológicos. Testimonios de un adn green consolidado y una coherencia transversal, señales de una continua investigación y de una vista siempre tendida al futuro que se declina en la innovación tecnológica de sistemas, puertas y muebles, realizados con el conocimiento que desea confiar al hombre sólo actividades de alto valor añadido.

Objective obtained thanks to the use of precious and recyclable materials, to the absence of substances that can be toxic to humans or harmful to the environment in every phase of the productive process, to the use of technology and evolved machinery, powered by clean energy derived from latest generation photovoltaic systems, installed on Giussano headquarters roof. Aluminium, glass, wood, synthetic leather: fully recyclable materials and partly already recycled, but also Ecoloursystem paints without solvents and ecological packing materials. Proofs of a reinforced green dna and wide coherence, signals of a continuous research and a glance directed to the future, that takes shape in the technological innovation of systems, doors and furniture, made with the awareness to entrust just high added value activities.





**Vetri laccati Ecolorsystem**  
Ecolorsystem lacquered glasses

Lucidi Opachi Glossy Mat			Lucidi Opachi Glossy Mat			Lucidi Opachi Glossy Mat			Lucidi Opachi Glossy Mat			Lucidi Opachi Glossy Mat		
40	115	Grigio cenere	53	95	Bianco neve	45	97	Avorio	50	108	Bianco latte	76	116	Rosso india
	121	Azzurro cera	59	105	Grigio chiaro	304	137	Platino	78	114	Sabbia	75	129	Amaranto
35	100	Blu notte	56	98	Lino	85	130	Tufo	74	110	Canapa	84	128	Moro
86	131	Blu oceano	41	104	Grigio ombra	69	126	Palladio	51	113	Nocciola	300	133	Rame
47	96	Grigio perla	88	132	Grigio scuro	57	106	Tortora	52	107	Corda	301	134	Peltro
36	117	Blu Londra	48	103	Grigio ardesia	58	99	Caffè	73	109	Giallo kashmir	83	127	Piombo
	122	Verde inglese				46	102	Nero	43	119	Laguna	302	135	Grafite
									33	111	Verde oliva	303	136	Bronzo

**Caratteristiche**

Ecolorsystem è la denominazione che contraddistingue l'esclusiva collezione di vetri laccati Rimadesio, disponibili in finitura lucida e opaca. Colori ecologici perchè prodotti utilizzando esclusivamente vernici all'acqua di ultima generazione, con cottura a 110°C. Una tecnologia produttiva all'avanguardia nell'ambito del vetro, con impianti interni totalmente robotizzati che assicurano risultati di altissima qualità e un ciclo di lavorazione a basso impatto ambientale. Resistenza alla corrosione conforme alla norma UNI EN ISO 9227. Resistenza agli sbalzi di temperatura conforme alla norma UNI 9429. Colori inalterabili nel tempo perchè applicati sulla superficie interna del vetro, al sicuro da macchie, polvere e umidità. Lo spessore del vetro crea un esclusivo effetto di "profondità".

**Vetri laccati lucidi**

Superficie perfettamente liscia. Brillantezza equivalente a 100 gloss. Vetri non trasparenti, caratterizzati dall'alto potere riflettente. Resistenza alla graffiatura superiore rispetto alle convenzionali superfici laccate.

**Vetri laccati opachi**

Superficie con effetto vellutato al tatto. Vetri non trasparenti, caratterizzati da un effetto di opacità molto marcato. Microsolcatura superficiale che conferisce un'elevata resistenza alla graffiatura. Refrattari alle impronte digitali.

**Characteristics**

Ecolorsystem is the name that distinguishes the exclusive Rimadesio lacquered glass collection in glossy and mat finishing. Ecological colours produced, using exclusively water paints of latest generation, cooked at 110° C. Cutting edge production technology in the area of glass, with a fully robotised in-house plant, that ensures very high quality results and a low environmental impact work cycle. Corrosion resistance conforms to the UNI EN ISO 9227 standard. Temperature fluctuation resistance conforms to the UNI 9429 standard. The colour is inside the double glass, safe from stains, dust and humidity. The thickness of the glass creates an exclusive "depth" effect.

**Glossy lacquered glasses**

Perfectly smooth surface. Brightness equivalent to 100 gloss. Not transparent glass, characterized by high reflectivity. Higher scratch resistance compared to conventional painted surfaces.

**Mat lacquered glasses**

Surface with velvet touch effect. Not transparent glasses, characterized by a very marked opacity effect. Surface high resistant to scratching. Refractory fingerprints.

**Eigenschaften**

Ecolorsystem ist der Name der neuen lackierten Glas-Kollektion von Rimadesio. Absolut ökologische Farben, da die modernsten Lackierungen, auf Wasser-Basis, an einer Temperatur von 110° C gekocht werden. Eine fortschrittliche Produktionstechnik in der Glasverarbeitung auf einer vollautomatisierten Anlage, die Ergebnisse höchster Qualität und gleichzeitig umweltfreundliche Verarbeitungsverfahren gewährleistet. Korrosionsprüfung gemäß Bestimmung UNI EN ISO 9227. Temperaturwechselprüfung gemäß Bestimmung UNI 9429. Die Farben sind unveränderlich, weil es auf die innere Oberfläche des Glases, sicher vor Flecken, Staub und Feuchtigkeit aufgetragen. Die Dicke des Glases erzeugt eine einzigartige Wirkung von "Tiefe".

**Hochglanzend lackierte Gläser**

Glaeser Vollkommen glatte Oberfläche. Helligkeit entsprechend 100 Gloss. Undurchsichtige Glaeser, durch eine hohe Reflektivität gekennzeichnet. Hoehere Kratzfestigkeit zu herkömmlichen lackierten Oberflächen verglichen.

**Matt lackierte Gläser**

Oberfläche mit "Velvet touch" Effekt. Undurchsichtige Glaeser, gekennzeichnet durch einen Matt-Effekt sehr ausgeprägt. Oberfläche, die eine hohe Resistenz gegen Kratzer gibt. Grosse Widerstand an Fingerabdrücke.

**Caractéristiques**

Ecolorsystem est le nom qui caractérise la collection exclusive de verres laqués de Rimadesio. Couleurs écologiques, parce que produites en utilisant exclusivement vernis à l'eau de dernière génération, cuites à 110° C. Une technologie de production avant-gardiste dans le domaine du verre, avec des équipements internes entièrement robotisés qui assurent des résultats de grande qualité et un cycle de production ayant un impact très faible sur l'environnement. Résistance à la corrosion conformément à la norme UNI EN ISO 9227. Résistance aux écarts de température conformément à la norme UNI 9429. Couleurs inaltérables parce que appliquée sur la surface interne du verre, à l'abri des taches, poussière et l'humidité. L'épaisseur du verre crée un effet unique de "profondeur".

**Verres laqués brillants**

Surface parfaitement lisse. Luminosité équivalent à 100 Gloss. Verres pas transparents, caractérisé par une haute réflectivité. Résistance aux rayures supérieure par rapport aux conventionnelles surfaces peintes.

**Verres laqués mats**

Surface avec effet toucher velours. Verres pas transparents avec caractéristique d'opacité très marquée. Surface avec une haute résistance aux rayures. Réfractaires aux empreintes digitales.

**Características**

Ecolorsystem es la denominación que marca la exclusiva colección de los cristales lacados Rimadesio, disponibles en acabado brillante y opaco. Colores ecológicos porque productos utilizando exclusivamente pinturas al agua de última generación, con cocción a 110° C. Una tecnología productiva a la vanguardia en el ámbito del cristal, con unas instalaciones internamente totalmente robotizadas que aseguran resultados de altísima calidad y un ciclo de tratamiento respetuoso del medio ambiente. Resistencia a la corrosión conforme a la norma UNI EN ISO 9227. Resistencia a las variaciones de temperatura conforme a la norma UNI 9429. Colores inalterables en el tiempo, porque aplicados en la superficie interna del cristal, al resguardo de manchas, polvo y humedad. El grosor del cristal crea un exclusivo efecto de "profundidad".

**Cristales lacados brillantes**

Superficie perfectamente lisa. Brillantez equivalente a 100 gloss. Cristales no transparentes, del alto poder reflectante. Resistencia a las rayas mucho más alta que las convencionales superficies lacadas.

**Cristales lacados opacos**

Superficie con efecto aterciopelado al tacto. Cristales no transparentes, del característico efecto de opacidad muy marcado. Microsurcos superficiales con alta resistencia a las rayas. Refrattarios a las huellas dactilares.

40	Grigio cenere	53	Bianco neve	45	Avorio	78	Sabbia	76	Rosso india
38	Azzurro cera	59	Grigio chiaro	304	Platino	74	Canapa	75	Amaranto
35	Blu notte	56	Lino	85	Tufo	51	Nocciola	84	Moro
86	Blu oceano	41	Grigio ombra	69	Palladio	52	Corda	300	Rame
47	Grigio perla	88	Grigio scuro	57	Tortora	73	Giallo kashmir	301	Peltro
36	Blu Londra	48	Grigio ardesia	58	Caffè	43	Laguna	83	Piombo
39	Verde inglese					33	Verde oliva	302	Grafite
								303	Bronzo

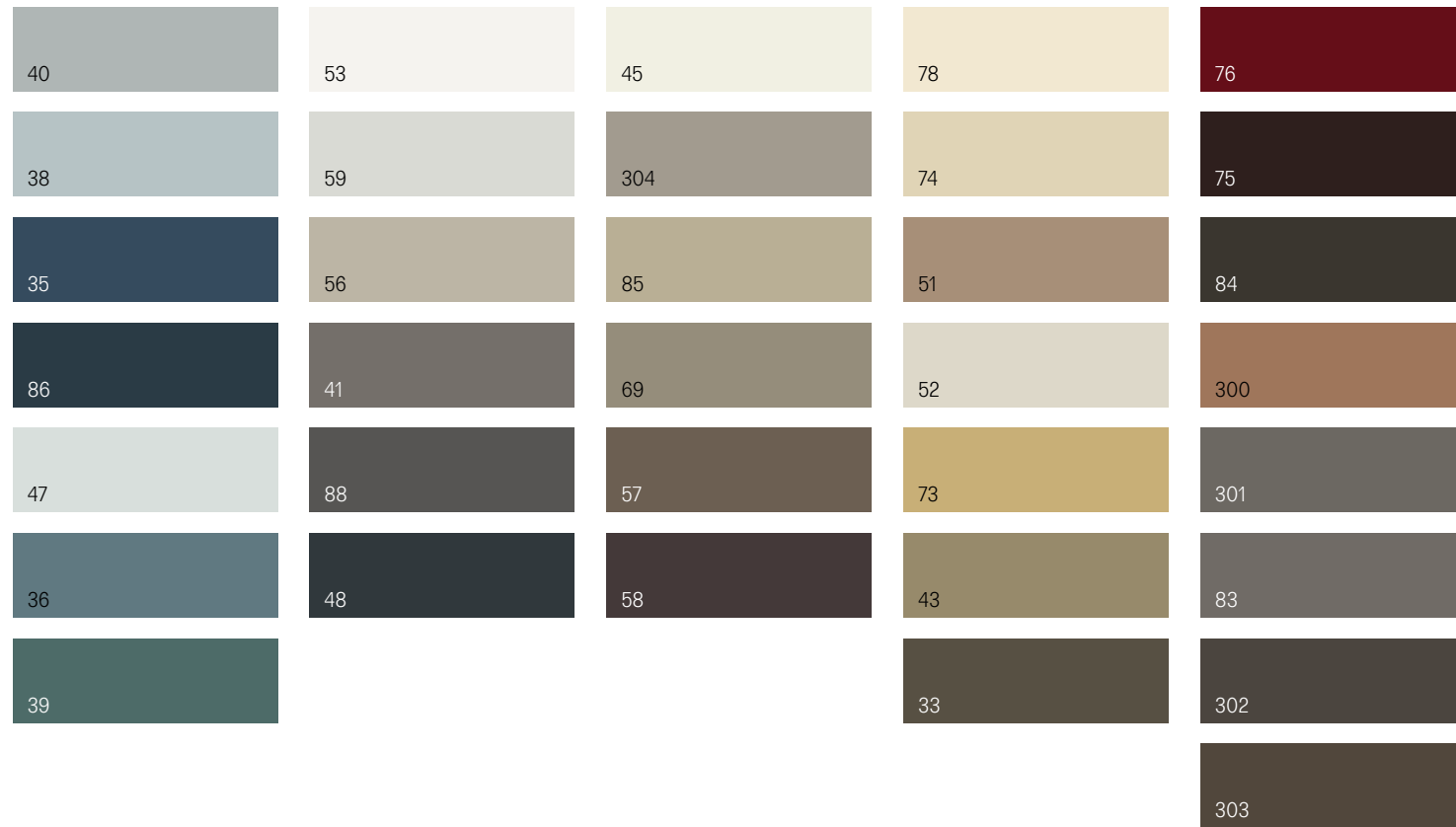

#### Caratteristiche

Ecolorsystem è la denominazione che contraddistingue l'esclusiva collezione di laccature opache Rimadesio, realizzate su componenti metallici, in legno e plastici. Colori ecologici perché prodotti utilizzando esclusivamente vernici all'acqua di ultima generazione, con cottura a 70° C. Una tecnologia produttiva all'avanguardia, con impianti interni robotizzati che assicurano risultati di altissima qualità e un ciclo di lavorazione a basso impatto ambientale. Resistenza alla corrosione della vernice ad acqua conforme alla norma UNI EN ISO 9227. Resistenza agli sbalzi di temperatura della vernice ad acqua conforme alla norma UNI 9429. Resistenza al distacco dello strato di vernice ad acqua verificato tramite processo di quadratura prima e dopo l'invecchiamento conforme alla norma UNI EN ISO 2409. Resistenza all'usura dello strato di vernice ad acqua mediante sfregamento secondo procedura Catas. Resistenza ai detersivi della vernice ad acqua conforme alla norma EN 12720.

#### Characteristics

Ecolorsystem is the name that distinguishes the exclusive Rimadesio lacquering collection in mat finishing, realized on metallic, wooden and plastic components. Ecological colours produced using exclusively water paints of latest technology, cooked at 70° C. A modern production technology, with fully robotised in-house plants that ensures very high quality results and a low environmental impact work cycle. Resistance to corrosion of the water paint in compliance with UNI EN ISO 9227 regulation. Resistance to temperature leap of water paint in compliance with UNI 9429 regulation. Resistance to detachment of the layer of water paint checked through the cross-cut test before and after the ageing in compliance with UNI EN ISO 2409 regulation. Resistance to use of the layer of water paint by rubbing according to Catas procedure. Resistance to detergent of water paint in compliance with EN 12720 procedure.

#### Charakteristik

Ecolorsystem ist die Bezeichnung, welche die exklusive Kollektion der matt lackierten Metall-, Holz- und Kunststoffkomponenten von Rimadesio auszeichnet. Umweltfreundliche Farbpalette, weil bei der Produktion ausschließlich auf 70° erhitzte, wasserlösliche Lacke der neuesten Generation verwendet werden. Eine fortschrittliche Produktionstechnologie mit Robotern welche Ergebnisse höchster Qualität und mit geringstmöglichen Umweltbelastungen sicherstellt. Korrosionsresistente, wasserbasierte Lacke gemäß der EU-Norm UNI EN ISO 9227. Temperaturwechselresistente, wasserbasierte Lacke gemäß der EU-Norm UNI 9429. Die verwendeten Lacke sind gemäß der EU-Norm UNI EN ISO 2409 resistent gegen Ablösung der Lackoberfläche vor und nach dem Alterungsprozess. Resistent bei der Verwendung des Lackes auf Wasserbasis, auf Reibung nach dem Catas Verfahren. Resistenz des Lackes auf Wasserbasis, auf Waschmittel laut Norm EN12720.

#### Characteristiques

Ecolorsystem est le nom qui caractérise la collection exclusive Rimadesio de laques mates sur pièces métalliques, en bois et en plastique. Couleurs écologiques parce qu'ils sont fabriqués en utilisant des peintures à base d'eau de dernière génération, avec un cuisson de 70°. Une technologie de production avant-gardiste, avec des équipements internes entièrement robotisés, qui assurent des résultats de haute qualité et un cycle de production avec un impact très faible sur l'environnement. Résistance à la corrosion de la peinture à base d'eau conformément à la norme UNI EN ISO 9227. Résistance aux écarts de température de la peinture à base d'eau conformément à la norme UNI 9429. Résistance au décollement de la couche de peinture à base d'eau, testée par le processus de coupe transversale avant et vieillissement après en conformité avec la norme UNI EN ISO 2409. Résistance à l'usure de la couche de peinture à l'eau par frottement selon la procédure Catas. Résistance aux détergents de la peinture à l'eau conforme à la norme EN 12720.

#### Características

Ecolorsystem es la denominación que distingue la exclusiva colección de laca mate Rimadesio, realizadas sobre componentes metálicos, en madera y plásticos. Colores ecológicos porque producidos usando solamente lacas base de agua de última generación, con cocción a 70°. Una tecnología productiva a la vanguardia, con sistemas internos robóticos que aseguran resultados de altísima calidad y un ciclo de producción de bajo impacto ambiental. Resistencia a la corrosión de la pintura a base de agua conforme a la norma UNI EN ISO 9227. Resistencia a los cambios de temperatura de la pintura al agua de conforme a la norma UNI 9429. Resistencia al desprendimiento de capa de laca verificado por medio del proceso de adherencia antes y después del envejecimiento conforme a la norma UNI EN ISO 2409. Resistencia al desgaste de lacapa de pintura de agua mediante el roce según el procedimiento Catas. Resistencia a los detergentes de la pintura al agua conforme a la norma EN 12720.

Collection designed by Giuseppe Bavuso

Art direction: Paolo Mojoli  
Graphic project: Iuma  
Photo: Santi Caleca, Federico Cedrone  
Styling: Martina Lucatelli  
Technical photo: F2 Fotografia  
Render: Alessandro Consonni  
Stage setup: Ottonove  
Films and print: Optima  
Printed in Italy / September 2018

Thanks to: Amini Carpets, Arper, Baxter, B&B, Carl Hansen & Søn, Flexform, Flos, Fontana Arte, Fritz Hansen, Henry Timi, Ittala Karakter, Living divani, Minotti, Nude Glass, Oluce, Pallucco, Rubelli, Salvatori, Sandola Marmi, Vitra, When Objects Work.



Awards		
1993	Siparium	Young & Design 1993
2000	Zenit	Award KBB
2001	Zenit	selezione Design Index ADI 2001
2002	Siparium	Top100 Frames
2005	Graphis	selezione Design Index ADI 2005
2007	Vela	selezione Design Index ADI 2007
2008	Vela	segnalazione XXI Premio Compasso d'Oro ADI
2015	Wind	winner Red Dot Award 2015
2016	Cover	AZ awards 2016 Best Furniture System
2016	Alambra	selezione Design Index ADI 2016
2017	Sail	selezione Design Index ADI 2017
2017	Soho	AZ awards 2017 Architectural products
2017	Daimon	Interior Design Magazine Best of Year awards

2013 **ADIMEMBER**

Modelli depositati e brevettati / Patented:  
Sail, Soho, Velaria, Stripe, Daimon, Graphis, Siparium, Zen, Zen frame, Moon, Vela, Luxor, Even, Aura, Spin, Link+, Planet, Flat, Alambra, Abacus living, Cover, Zenit, Dress bold e Abacus.

Marchi registrati / Registered trademarks:  
Rimadesio, Ecoloursystem, Siparium.

Rimadesio spa  
Via Furlanelli 96  
20833 Giussano (Mb) Italy  
T +39 0362 3171  
F +39 0362 317317  
www.rimadesio.it  
rimadesio@rimadesio.it

Flagship store Milano  
via Visconti di Modrone 26  
20122 Milano Italy  
T-F +39 02 76280708  
milano@rimadesio.it

Italy showroom:  
Milano, Roma, Genova, Torino, Como, Brescia, Parma, Firenze, Pescara, Palermo, Catania, Cosenza.

Worldwide showroom:  
Genève, Wien, Nice, Madrid, Barcelona, Bilbao, Marbella, Vigo, Bruxelles, Munich, Moscow, Saint Petersburg, Istanbul, Beirut, Tehran, Tokyo, Seoul, Shanghai, Beijing, Hangzhou, Hong Kong, Singapore, Manila, Hyderabad, New Delhi, New York, Mexico City, Santiago del Chile, Cape Town, Casablanca.

Follow us on **facebook**